

# Panasonic

## Quick Reference Guide

---

IP Proprietary Telephone  
Model No. **KX-NT543/KX-NT546**  
**KX-NT560**

Thank you for purchasing an IP Proprietary Telephone (IP-PT). Please read this manual carefully before using this product and save this manual for future use. For more details, please refer to the manuals of the PBX.

Manuals and supporting information are provided on the Panasonic Web site at:  
<https://panasonic.net/cns/pcc/support/pbx/>

### Note

- In this manual, the suffix of each model number (e.g., KX-NT546**NE**) is omitted unless necessary.

### Open Source Software Notice

Parts of this product use open source software. For details about the open source software, refer to the following Web site at:

<https://panasonic.net/cns/pcc/support/pbx/>

### Trademarks

- The Bluetooth® word mark and logos are owned by the Bluetooth SIG, Inc. and any use of such marks by Panasonic Corporation is under licence.
- All other trademarks identified herein are the property of their respective owners.

# For Your Safety

To reduce the risk of injury, loss of life, electric shock, fire, malfunction, and damage to equipment or property, always observe the following safety precautions.



Denotes a potential hazard that could result in serious injury or death.

### General Safety



- Do not disassemble this unit. Dangerous electrical shock could result. The unit must only be disassembled and repaired by qualified service technicians.
- Never attempt to insert wires, pins, etc. into the vents or other holes of this unit.
- To prevent possible fire or electric shock, do not expose this unit to rain or moisture.
- Do not splash water on the AC adaptor or the power cord, nor get them wet. Doing so can result in fire, electric shock, or injury. If they do get wet, immediately disconnect the AC adaptor and power cord, and contact an authorised service centre.
- Do not touch the AC adaptor for extended periods of time. Doing so can lead to low-degree burns.



- If damage to the unit exposes any internal parts, immediately disconnect the cable or cord. If the power is supplied from the network to the IP-PT [Power-over-Ethernet], disconnect the Ethernet cable. Otherwise, disconnect the AC adaptor cord. Then return this unit to a service centre.



- Unplug this unit from the AC outlet and have the unit serviced by qualified service personnel in the following cases:
  - A. When the power supply cord or plug is damaged or frayed.
  - B. If liquid has been spilled on the unit.
  - C. If the unit has been exposed to rain or water.
  - D. If the unit does not work normally by following the manual. Adjust only controls covered by the manual. Improper adjustment may require repair by an authorised service centre.
  - E. If the unit has been dropped, or damaged.
  - F. If the unit's performance deteriorates.
- This handset earpiece is magnetised and may retain small ferrous objects.
- The use of excessive sound volume through earphones, headphones, or headsets may cause hearing loss.
- Disconnect this unit from power outlet/the Ethernet cables if it emits smoke, an abnormal smell, or makes unusual noise. These conditions can cause fire or electric shock. Confirm that smoke has stopped and contact an authorised service centre.

### Installation



- Do not make power connections that exceed the ratings for the AC outlet or power equipment. If the power rating of a surge protector, etc. is exceeded, it can cause a fire due to heat buildup.
- Do not bundle up the AC adaptor cord. The cord may become damaged, which can lead to a fire, electric shock, or electric short.



- The unit should only be connected to a power supply of the type as shown on the label on the unit.
- Completely insert the AC adaptor into the AC outlet. Failure to do so may cause electric shock and/or excessive heat resulting in a fire.

## For Your Safety

---

### Medical (KX-NT560 only)



- Do not use the product in health care facilities if any regulations posted in the area instruct you not to do so. Hospitals or health care facilities may be using equipment that could be sensitive to external RF energy.



- Consult the manufacturer of any personal medical devices, such as pacemakers or hearing aids, to determine if they are adequately shielded from external RF (radio frequency) energy (the product operates in the frequency range of 2.402 GHz to 2.480 GHz and the power output is 2.5 mW [max.]).

### Placement



- Care should be taken so that objects do not fall onto, and liquids are not spilled into, the unit. Do not subject this unit to excessive smoke, dust, moisture, mechanical vibration, shock, or direct sunlight.
- Do not place heavy objects on top of this unit.



- Place this unit on a flat surface.
- Allow 10 cm clearance around the unit for proper ventilation.

### Wall Mounting



- Make sure that the wall that the unit will be attached to is strong enough to support the unit (approx. 1.5 kg).
- Only use the optional wall mount kit with the unit. The wall mount kit includes the necessary screws, washers, and wall mounting adaptor.
- When driving the screws into the wall, be careful to avoid touching any metal laths, wire laths or metal plates in the wall.
- When this unit is no longer in use, make sure to detach it from the wall.

**CAUTION**

Denotes a hazard that could result in minor injury or damage to the unit or other equipment.



- Keep the unit away from heating appliances and devices that generate electrical noise, such as fluorescent lamps, motors and televisions. These noise sources can interfere with the performance of the unit. It also should not be placed in rooms where the temperature is less than 0 °C or greater than 40 °C.



- Wipe the unit with a soft cloth. Do not clean the unit with abrasive powders or with chemical agents such as benzine or thinner.
- The handset hook poses a choking hazard. Keep the handset hook out of reach of children.
- When left unused for a long period of time, disconnect the unit from the AC outlet. When the unit receives power from a PoE power supply, disconnect the Ethernet cables.
- When the unit is mounted on a wall, make sure the cables are securely fastened to the wall.

**Note**

- If the unit does not operate properly, disconnect the AC adaptor cord and Ethernet cables and then connect again.
- If you are having problems making calls, disconnect the Ethernet cable and connect a known working IP-PT. If the known working IP-PT operates properly, have the defective IP-PT repaired by an authorised Panasonic factory service centre. If the known working IP-PT does not operate properly, check the PBX and the Ethernet cable.
- Under power failure conditions, the IP-PT may not operate. Please ensure that a separate telephone, not dependent on local power, is available for use in remote sites in case of emergency.
- For information regarding network setup of the IP-PT such as IP addresses, please refer to the Installation Manual for the PBX.

## ***For Your Safety***

---

- If an error message is shown on your display, consult your dealer or the network administrator.
- Use only the correct Panasonic handset.

---

## **Important Safety Instructions**

When using this unit, basic safety precautions should always be followed to reduce the risk of fire, electric shock and injury to persons, including the following:

- Do not use the unit near water, for example, near a bathtub, washbowl, kitchen sink, or laundry tub, in a wet basement, or near a swimming pool.
- Avoid using a telephone (other than a cordless type) during an electrical storm. There may be a remote risk of electric shock from lightning.
- Do not use the telephone to report a gas leak in the vicinity of the leak.

**SAVE THESE INSTRUCTIONS**

## Important Information

---

### For Users in Australia and the United Kingdom

- This unit is capable of being used in conjunction with hearing aids fitted with inductive coil pick-ups. The handset should be held as for normal conversation. For operation, the hearing aid should be set to its "T" position or as directed in the operating instructions for the hearing aid.
- This unit is designed to aid the visually handicapped to locate dial keys and buttons.



---

### For Users in the United Kingdom

- This unit is designed to be installed under controlled conditions of ambient temperature and a relative humidity.
- Avoid installing the unit in damp or humid environments, such as bathrooms or swimming pools.
- 999 and 112 can be dialled on the product after accessing the outside line for the purpose of making outgoing calls to the BT emergency (999) and (112) services.

---

### For Users in New Zealand

- This equipment shall not be set to make automatic calls to the Telecom '111' Emergency Service.
- This device is equipped with pulse dialling while the telecom standard is DTMF tone dialling. There is no guarantee that the Telecom Lines will always continue to support pulse dialling.

### PTC General Warning

- The grant of a Telepermit for any item of terminal equipment indicates only that Telecom has accepted that the item complies with minimum conditions for connection to its network. It indicates no endorsement of the product by Telecom, nor does it provide any sort of warranty. Above all, it provides no assurance that any item will work correctly in all respects with another item of Telepermitted equipment of a different make or model, nor does it imply that any product is compatible with all of Telecom's network services.

### The Use of IP Networks through the PSTN

- Internet Protocol (IP) by its nature introduces delay into speech signals as each data packet is formulated and addressed. Telecom Access Standards

## Important Information

---

recommends that suppliers, designers and installers using this technology for calls to or from the PSTN refer to ITU E Model requirements in the design of their networks. The overall aim is to minimise delay, distortion and other transmission impairments, particularly for those calls involving cellular and international networks, which already suffer extensive delay.

### Echo cancellation

- Echo cancellers are not normally required in the Telecom PSTN because geographic delays are acceptable where CPE return loss is maintained within Telepermit limits. However, those private networks making use of Voice over IP technology are required to provide echo cancellation for all voice calls. The combined effect of audio/VoIP conversion delay and IP routing delay can cause the echo cancellation time of  $\geq 64$  mS to be required.

---

## Information for Users on Collection and Disposal of Old Equipment and used Batteries

These symbols on the products, packaging, and/or accompanying documents mean that used electrical and electronic products and batteries should not be mixed with general household waste.

For proper treatment, recovery and recycling of old products and used batteries, please take them to applicable collection points, in accordance with your national legislation and the Directives 2002/96/EC and 2006/66/EC. By disposing of these products and batteries correctly, you will help to save valuable resources and prevent any potential negative effects on human health and the environment which could otherwise arise from inappropriate waste handling.

For more information about collection and recycling of old products and batteries, please contact your local municipality, your waste disposal service or the point of sale where you purchased the items.

Penalties may be applicable for incorrect disposal of this waste, in accordance with national legislation.



### For business users in the European Union

If you wish to discard electrical and electronic equipment, please contact your dealer or supplier for further information.



### Information on disposal in other countries outside the European Union

These symbols are only valid in the European Union. If you wish to discard these items, please contact your local authorities or dealer and ask for the correct method of disposal.





### **Note for the battery symbol (bottom two symbol examples):**

This symbol might be used in combination with a chemical symbol. In this case it complies with the requirement set by the Directive for the chemical involved.

---

## **For Users in the European Union**

### **For information of Compliance with EU relevant Regulatory Directives, Contact to Authorised Representative:**

Panasonic Testing Centre

Panasonic Marketing Europe GmbH

Winsbergring 15, 22525 Hamburg, Germany

### **KX-NT560 only**

Hereby, Panasonic Corporation declares that the radio equipment described in this manual is in compliance with Directive 2014/53/EU. The full text of the EU declaration of conformity is available at the following internet address:

**<https://www.ptc.panasonic.eu/compliance-documents>**

# Accessory Information

## Included Accessories

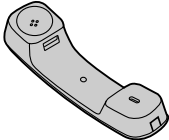
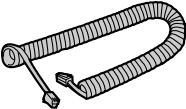
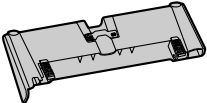
Handset (1)	Handset Cord (1)	Stand (1)
		

### Note

- The illustrations may differ from the appearance of the actual product.

## Optional Accessories

<b>AC adaptor</b> *1*2	KX-A239BX (PQLV206CE/PNLV6510)/ KX-A239AL (PQLV206AL/PNLV6510)/ KX-A239UK (PQLV206E/PNLV6510)/ KX-A239EJ (PQLV206E/PNLV6510)/ KX-A239X (PQLV206)/ KX-A420BR (PSLP1662)
<b>Wall Mount Kit</b>	KX-A433X

- \*1 To order an optional AC adaptor, please order using the "KX-A239xx/  
KX-A420BR" model number (not "PQLV206xx/PNLV6510/  
PSLP1662").

- \*2 For users in Argentina, power can only be supplied by PoE.

### Note

- Some optional accessories are not available in some countries/areas.  
For details, consult your dealer.

# Location of Controls

KX-NT543  
KX-NT546

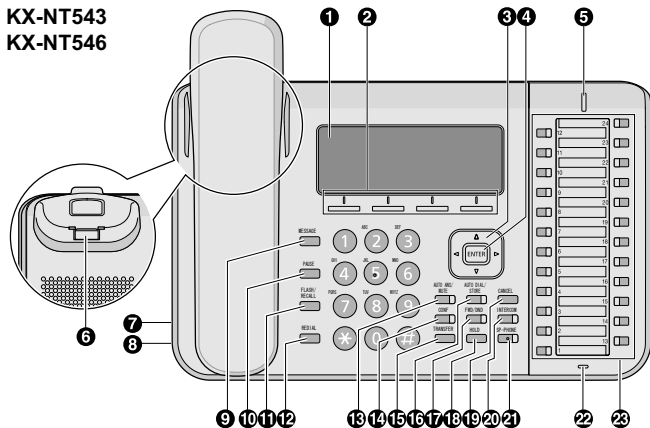

KX-NT560

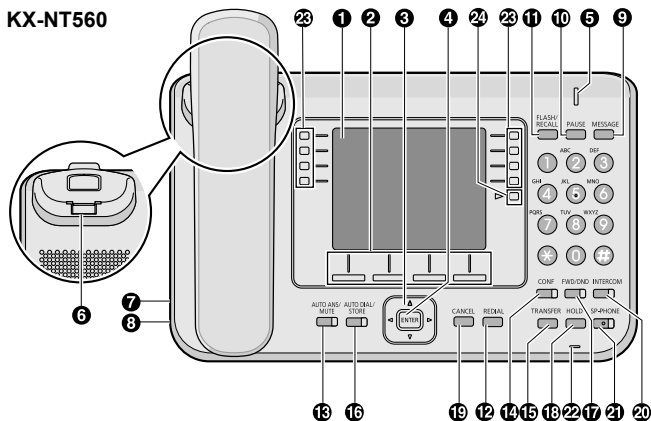

## ***Location of Controls***

---

- 1 LCD (Liquid Crystal Display):**  
KX-NT543: 3 lines, KX-NT546: 6 lines, KX-NT560: 4.4-inch
- 2 Soft Buttons (S1-S4):** S1-S4 (located from left to right) are used to select the item displayed on the bottom line of the display.
- 3 Navigator Key:** Used to adjust the volume and the display contrast or select desired items.
- 4 ENTER:** Used to assign the selected item.
- 5 Message/Ringer Lamp:** When you receive an intercom call, the lamp flashes green, and on an outside call, the lamp flashes red. When someone has left you a message, the lamp stays on red.
- 6 Handset Hook:** Keeps the handset stable when the unit is mounted on a wall.
- 7 EHS (Electronics Hook Switch) Jack**
- 8 Headset Jack**
- 9 MESSAGE:** Used to leave a message waiting indication or call back the party who left the message waiting indication.
- 10 PAUSE:** Used to insert a pause when storing a telephone number. This button is also used for programming this unit.
- 11 FLASH/RECALL:** Used to disconnect the current call and make another call without hanging up.
- 12 REDIAL:** Used to redial the last dialled number.
- 13 AUTO ANS/MUTE:** Used to receive an incoming call in hands-free mode or mute the microphone/handset during a conversation.
- 14 CONF:** Used to establish a multiple party conversation.
- 15 TRANSFER:** Used to transfer a call to another party.
- 16 AUTO DIAL/STORE:** Used for System/Personal Speed Dialling or storing programme changes.
- 17 FWD/DND:** Used to switch Call Forwarding or Do Not Disturb on your extension.

- 18 **HOLD:** Used to place a call on hold.
- 19 **CANCEL:** Used to cancel the selected item.
- 20 **INTERCOM:** Used to make or receive intercom calls.
- 21 **SP-PHONE (Speakerphone):** Used for performing hands-free operations.
- 22 **Microphone:** Used for hands free conversations.
- 23 **Flexible CO Buttons:** Used to seize an outside line or perform a feature that has been assigned to the key.
- 24 **NEXT PAGE Key:** Used to switch the page for the Self Labelling feature. (KX-NT560 only)

## Before Operating the Telephone

### Speaker volume

While in a hands-free conversation  
Press [▲] or [▼] to adjust the volume.

### Handset/Headset volume\*1

While using the handset or headset  
Press [▲] or [▼] to adjust the volume.

### Ringer volume

While on-hook or receiving a call  
Press [▲] or [▼] to adjust the volume.

### LCD Contrast

While on-hook

1. Press the **PROG** soft button (S1).
2. Enter 0①.
3. Press [ENTER].
4. Press [▲] or [▼] to adjust the LCD contrast.
5. Press [ENTER].
6. Press [CANCEL].

### Ring Tone

1. Press the **PROG** soft button (S1).
2. Press a flexible CO button or [INTERCOM] 2 times.
3. Enter 2 digits (01-30) using the dial keys (0-9), or press [▲] or [▼] to select the ring tone.
4. Press [ENTER].
5. Press [CANCEL].

\*1 If you hear your own voice through the handset or headset, decrease the volume.

### LCD Backlight

While on-hook

1. Press the **PROG** soft button (S1).
2. Enter 04.
3. Press [ENTER].
4. Press a dial key to select the LCD backlight mode.  
①: Automatic  
①: Always ON  
②: Always OFF
5. Press [ENTER].
6. Press [CANCEL].

### Registering the Bluetooth® headset (KX-NT560 only)

1. Set the Bluetooth headset to pairing mode by following the instructions provided with the headset.
2. Press the **PROG** soft button (S1).
3. Enter 66.
4. Press [ENTER].
5. Enter the Pass Key and press [ENTER].\*1
6. Press [CANCEL].

### Confirming the ID of the Bluetooth headset and deregistering the Bluetooth headset (KX-NT560 only)

1. Press the **PROG** soft button (S1).
2. Enter 67.
3. Press [ENTER].\*2\*3
4. Press [ENTER] to deregister the headset.
5. Press [CANCEL].

- \*1 For more information regarding the Pass Key of your headset, refer to the operating instructions of your headset.
- \*2 Confirm that the displayed ID is the ID of your headset. For more information regarding the ID of your headset, refer to the operating instructions of your headset.
- \*3 If you do not wish to perform deregistration, press [CANCEL] 3 times.

## Feature Operations

---

### Making Calls

#### Calling

##### **[To an extension]**

1. Go off-hook.
2. Dial an extension number.

##### **[To an outside party]**

1. Go off-hook.
2. Press a flexible CO button.
3. Dial the outside party's phone number.

#### Redial

1. Go off-hook.
2. Press [REDIAL].

#### Quick Dialling

1. Go off-hook.
2. Dial a quick dialling number.

#### Doorphone Call

1. Go off-hook.
2. Enter \*31.
3. Enter a doorphone number (2 digits).
4. After the confirmation tone, talk.

#### System Speed Dialling

1. Go off-hook.
2. Press [AUTO DIAL/STORE].
3. Enter a system speed dialling number (3 digits).



**Personal Speed Dialling****【To store】**

1. Go off-hook.
2. Enter **\*30**.
3. Enter a personal speed dialling number (2 digits).
4. Enter the phone number to store (max. 32 digits).<sup>\*1</sup>
5. Press **#**.
6. After the confirmation tone, go on-hook.

**【To dial】**

1. Go off-hook.
2. Press [AUTO DIAL/STORE].
3. Enter **\***.
4. Enter a personal speed dialling number (2 digits).

**One-touch Dialling****【To store】**

1. Press the **PROG** soft button (S1).
2. Press a flexible CO button.
3. Enter **2**.
4. Enter the number to store (max. 32 digits).<sup>\*1</sup>
5. Press [ENTER].
6. Enter the text to store (max. 12 digits).<sup>\*2</sup>
7. Press [ENTER].<sup>\*2</sup>
8. Press [CANCEL].

**【To dial】**

1. Go off-hook.
2. Press the flexible CO button assigned as a One-touch Dialling button.

<sup>\*1</sup> Enter the outside line access number before an outside phone number.

<sup>\*2</sup> KX-NT560 only

### During a Conversation

#### Call Hold

##### **[To hold]**

1. Press [HOLD].
2. After the confirmation tone, go on-hook.

##### **[To retrieve a call at the holding extension]**

1. Go off-hook.
2. Press a flexible CO button or [INTERCOM].

##### **[To retrieve an outside call from another extension]**

1. Go off-hook.
2. Press a flexible CO button.

#### Call Transfer

##### **[To an extension]**

1. Press [TRANSFER].
2. After the confirmation tone, dial an extension number.
3. Talk.
4. Go on-hook.

##### **[To an outside party]**

1. Press [TRANSFER].
2. After the confirmation tone, press a flexible CO button.
3. Dial an outside phone number.
4. Talk.
5. Go on-hook.

## Setting the Telephone According to Your Needs

### Do Not Disturb

1. Go off-hook.
2. Enter \*71.
3. Press a dial key to select the setting.  
0: Both outside and intercom calls  
1: Outside calls only  
2: Intercom calls only
4. To enable Do Not Disturb, enter 1.  
To cancel Do Not Disturb, enter 0.
5. After the confirmation tone, go on-hook.

### Timed Reminder

#### **[To set]**

1. Go off-hook.
2. Enter \*7601.
3. Enter the hour and minute (4 digits).
4. If 12-hour-time display is set, enter 0 (AM) or 1 (PM).
5. Enter 0 (1 time) or 1 (daily).
6. After the confirmation tone, go on-hook.

#### **[To cancel]**

1. Go off-hook.
2. Enter \*7600.
3. After the confirmation tone, go on-hook.

#### **[To stop or answer the ring back]**

1. Press [INTERCOM], or go off-hook.

### Useful Features

#### Multiple Party Conversation

##### **[To add other parties during a conversation]**

1. Press [CONF].
2. After the confirmation tone, dial the phone number of the party to add.
3. Talk to the new party.
4. Press [CONF].
5. After the confirmation tone, talk with multiple parties.

##### **[To leave a conference]**

1. Press [CONF].
2. After the confirmation tone, go on-hook.

---

### Before Leaving Your Desk

#### Call Forwarding

1. Go off-hook.
2. Enter \*7①.
3. Press a dial key to select the types of calls to apply this feature to.  
①: Both outside and intercom calls  
②: Outside calls only  
③: Intercom calls only
4. Press a dial key to select the status.  
④: All calls  
⑤: Busy  
⑥: No answer  
⑦: Busy/No answer  
⑧: Cancel\*1
5. Enter an extension number, and then enter #, or enter a CO line access number, an outside phone number, and then enter #.
6. After the confirmation tone, go on-hook.

\*1 If you enter ⑧ in Step 4, you can skip steps 5 and 6.

### Self Labelling (KX-NT560 only)

The KX-NT560 IP-PT features 8 flexible buttons around an LCD screen. Each item can be named on the LCD screen through personal or system programming to reflect the function of its corresponding flexible button. Additionally, the flexible buttons can be organised into 4 “pages”, allowing you to assign a total of 32 items to the 8 flexible buttons. You can toggle between pages by pressing the NEXT PAGE key, as follows:

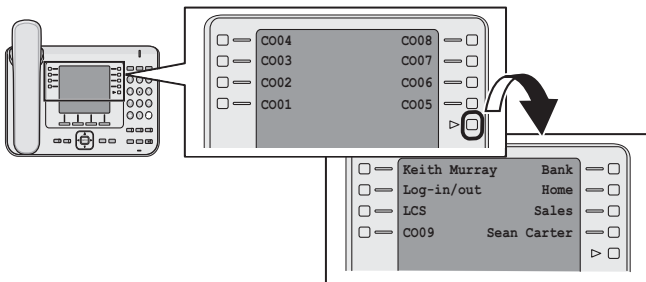

#### Storing a One-touch Dialling button, and setting the displayed text for the Self Labelling LCD Display

1. Press the **PROG** soft button (S1).
2. Press a flexible CO button, or press the NEXT PAGE key, and then press a flexible CO button.
3. Enter ②.
4. Enter the number to store (max. 32 digits).<sup>\*1</sup>
5. Press [ENTER].
6. Enter the text to store (max. 12 digits).
7. Press [ENTER].
8. Press [CANCEL].

<sup>\*1</sup> Enter the outside line access number before an outside phone number.

# Installation and Setup

### Note

- Panasonic assumes no responsibility for injuries or property damage resulting from failures arising out of improper installation or operation inconsistent with this documentation.

---

## Attaching the Stand

### Note

- If you place the display face down when you attach the stand, be sure to place a soft cloth under the display. Failure to do so may result in damage to the display.
- 1 Insert the catches (A) of the stand into hooks located in the unit.
  - 2 Gently push the stand in the direction indicated until it locks into place. The stand will be mounted in the high position.

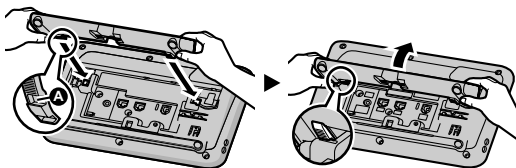

---

## Removing the Stand

- 1 Hold the stand with both hands.
- 2 Gently rotate the stand in the direction indicated until it is released.

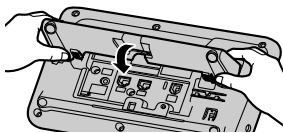

## Connections

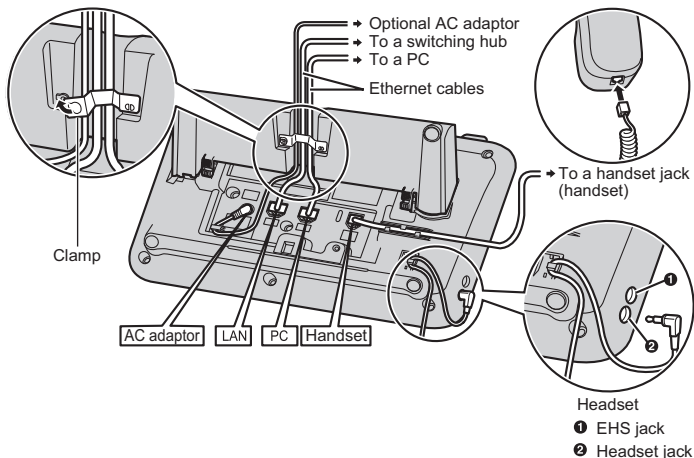

### CAUTION

#### Optional AC Adaptor

- Use a Panasonic AC adaptor (Page 10).
- The AC adaptor is used as the main disconnect device. Ensure that the AC outlet is installed near the unit and is easily accessible.

#### When connecting a headset

- Ensure that the headset cord has slack and is not pulled tight during use to prevent damage to the connectors.
- Cords used to connect devices to the EHS jack or headset jack must be less than 3 m in length.

#### Note

- The following headsets can be used with this unit. (Not all operations with the headsets can be guaranteed.)
  - Wired headsets  
Panasonic KX-TCA400, KX-TCA430, RP-TCA400 or RP-TCA430

## Installation and Setup

---

- EHS headsets
- Bluetooth headsets (KX-NT560 only)

For up-to-date information about headsets that have been tested with this unit, please contact your dealer.

### When selecting Ethernet cables (not included)

- Use flexible cables without jack covers. Do not use cables with a hard coating that may tear or crack when bent.

To prevent damage to the cables, use cables that do not protrude from the bottom of the base.

Connect the cables as shown in the following illustration.

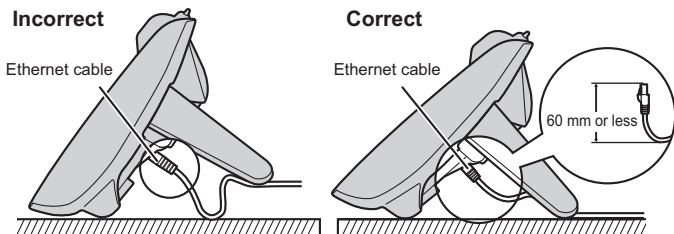

- Use a straight CAT 5e (or higher) Ethernet cable (not included) that is 6.5 mm in diameter or less.

### When connecting to a switching hub

- If PoE is available, an AC adaptor is not needed.
- KX-NT543/KX-NT546 complies with the PoE Class 2 standard.  
KX-NT560 complies with the PoE Class 3 standard.

### When connecting a PC

- The PC port does not support PoE for connected devices.

### When connecting cables and the AC adaptor

- Ensure that the Ethernet cables and the AC adaptor cord are clamped to prevent damage to the connectors.



## Wall Mounting

- 1 Insert the 5 tabs of the wall mounting adaptor into the designated openings in the base, and then slide the wall mounting adaptor in the direction of the arrow until it clicks.

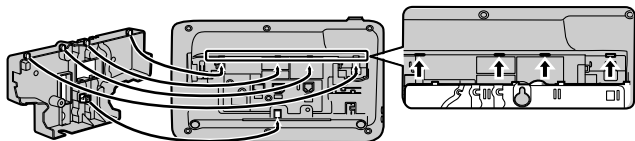

- 2 Fasten the wall mounting adaptor to the base with 1 screw. (Recommended torque: 0.4 N·m [4.08 kgf·cm] to 0.6 N·m [6.12 kgf·cm])
- 3 Connect the cables to the unit, and run the cables through the wall mounting adaptor, as shown in the illustration below.
- 4 Drive the 2 screws into the wall either 83 mm or 100 mm apart, and mount the unit on the wall.

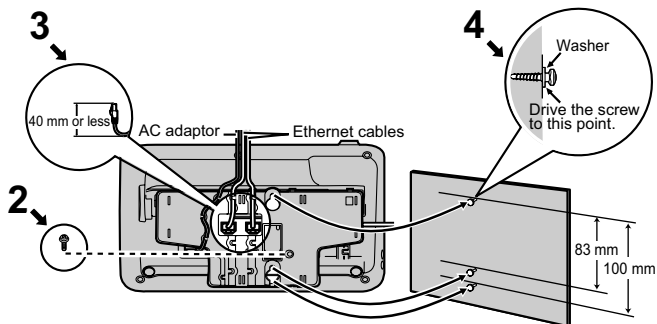





One screw here

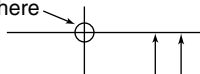

## WALL MOUNTING TEMPLATE

1. Drive the screws into the wall as indicated.
2. Hook the unit onto the screw heads.

### Note

Make sure to set the print size to correspond with the size of this page. If the dimensions of the paper output still deviate slightly from the measurements indicated here, use the measurements indicated here.

100 mm  
83 mm

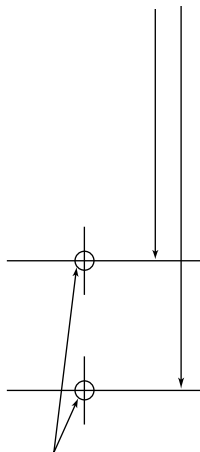

One screw at either point