



Grandstream Networks, Inc.

WP810/WP822/WP825

Administration Guide



WP810/WP822/WP825 - Administration Guide

WELCOME

WP810/WP822/WP825 are Cordless Wi-Fi IP Phones featuring dual-band 802.11a/b/g/n/ac Wi-Fi and supports Wi-Fi roaming. The combination of advanced telephony features and durability make them ideal for mobilizing your VoIP network in residences, warehouses, retail stores, hotels and many more environments. Due to a ruggedized design, these phones are safe for accidental drops and they are as well waterproof and dustproof, with large rechargeable batteries for long period of use, making them an ideal addition for homes and businesses alike.

PRODUCT OVERVIEW

Feature Highlights

The following table contain the major features of the WP810, WP822 and WP825:

 <p>WP810</p>	<ul style="list-style-type: none">● 2 SIP accounts and 2 lines.● 3-way audio conference calls.● Dual-band 802.11a/b/g/n/ac Wi-Fi.● Wi-Fi roaming.● 120 hours standby time.● 6 hours talk time.
 <p>WP822</p>	<ul style="list-style-type: none">● 2 SIP accounts and 2 lines.● 3-way audio conference calls.● Dual-band 802.11a/b/g/n/ac Wi-Fi.● Wi-Fi roaming.● 200 hours standby time.● 8 hours talk time.

 <p style="text-align: center;">WP825</p>	<ul style="list-style-type: none"> ● 2 SIP accounts and 2 lines. ● 3-way audio conference calls. ● Dual-band 802.11a/b/g/n/ac Wi-Fi. ● Wi-Fi roaming. ● 200 hours standby time. ● 8 hours talk time.
-----------------------------------------------------------------------------------------------------------------------------------	------------------------------------------------------------------------------------------------------------------------------------------------------------------------------------------------------------------------------------------------------------------

Table 1: WP810/WP822/WP825 Features at a Glance

Technical Specifications

The following table resumes all the technical specifications including the protocols/standards supported, voice codecs, telephony features, languages and upgrade/provisioning settings.

○ **WP810**

Protocols/Standards	SIP RFC3261, TCP/IP/UDP, RTP/RTCP, HTTP/HTTPS, ARP, ICMP, DNS (A record, SRV, NAPTR), DHCP, SSH, TFTP, NTP, STUN, SIMPLE, 802.1x, TLS, SRTP, IPv6
Voice Codecs and Capabilities	Support for G.711 μ /a, G.729A/B, G.722 (wide-band), iLBC, Opus, in-band and out-of-band DTMF (In audio, RFC2833, SIP INFO), VAD, CNG, AEC, PLC, AJB, AGC, ANS
Graphic Display	1.8-inch (128×160) TFT color LCD
Peripherals	2 soft keys, dial, hangup, speakerphone, phonebook, backlit keypad, proximity sensor, vibration motor, volume button and navigation keys
Push-to-Talk	Customizable button for push-to-talk.
Auxiliary Ports	3.5 mm headset jack, Micro-USB port for charging, dual-MIC, dual-color MWI LED.
Telephony Features	Hold, transfer, forward, 3-way audio conference, downloadable phonebook XML (up to 500 items), call waiting, call log (up to 100 records), off-hook auto dial, auto answer, flexible dial plan, personalized music ringtones, server redundancy and fail-over, push to talk
Security	User and administrator level passwords, MD5 and MD5-sess based authentication, 256-bit AES based secure configuration file, SRTP, TLS, 802.1x media access control
HD Audio	Yes, both on handset and speakerphone with support for wideband audio, HAC supported
QoS	802.11e and Layer 3 (ToS, DiffServ, MPLS) QoS
Multi-language	English, Chinese, German, French, Italian, Portuguese, Russian, Spanish, Turkish Japanese and more
Upgrade/ Provisioning	Firmware upgrade via TFTP/HTTP/HTTPS/FTP/FTPS, mass provisioning using encrypted XML

	configuration file, manual upload.
Power & Green Energy Efficiency	<p>Universal power adapter included</p> <p>Input: 100-240VAC; Output: +5VDC, 1A (5W)</p> <p>1500mA Li-ion battery, 120h standby time and 6h talk time</p>
Physical	<p>Handset Dimensions : 158.5 x 50 x 22.5mm</p> <p>Charger cradle dimensions : 81.15 x 75.89 x 36.36mm</p> <p>Handset weight: 120g</p> <p>Handset package weight (not including QIG): 340g</p>
Temperature and Humidity	<p>Operating Temperature: 0~45°C; Operating Humidity: 10~90%(non-condensing)</p> <p>Storage Temperature: -20~60°C; Storage Humidity:10~90%(non-condensing)</p>
Package Contents	<p>Handset unit, universal power supply, charger cradle, belt clip, 1 Li-ion battery.</p> <p>Quick Installation Guide.</p>
Compliance	FCC, CE, RCM, IC

Table 2: WP810 Technical Specifications

○ **WP822**

Protocols/Standards	SIP RFC3261, TCP/IP/UDP, RTP/RTCP, HTTP/HTTPS, ARP, ICMP, DNS (A record, SRV, NAPTR), DHCP, SSH, TFTP, NTP, STUN, SIMPLE, 802.1x, TLS, SRTP, IPv6
Voice Codecs and Capabilities	Support for G.711μ/a, G.729A/B, G.722 (wide-band), iLBC, Opus, in-band and out-of-band DTMF (In audio, RFC2833, SIP INFO), VAD, CNG, AEC, PLC, AJB, AGC, ANS
Graphic Display	2.4 inch (240x320) TFT color LCD
Peripherals	3 soft keys, dial, hang-up, speakerphone, phonebook, backlit keypad, proximity sensor, vibration motor, volume button, navigation keys, and accelerometer supporting configurable gestures
Push-to-Talk	Customizable button for push-to-talk.
Auxiliary Ports	3.5 mm headset jack, Micro-USB port for charging, dual-MIC, dual-color MWI LED.
Telephony Features	Hold, transfer, forward, 3-way audio conference, call waiting, call log (up to 100 records), downloadable phonebook (XML, up to 500 items) off-hook auto dial, auto answer, flexible dial plan, personalized music ringtones, server redundancy and fail-over, push to talk, LDAP
Security	User and administrator level passwords, MD5 and MD5-sess based authentication, 256-bit AES based secure configuration file, SRTP, TLS, 802.1x media access control
HD Audio	Yes, both on handset and speakerphone with support for wideband audio, HAC supported
QoS	802.11e (WMM) and Layer 3 (ToS, DiffServ, MPLS) QoS
Multi-language	English, Chinese, German, French, Italian, Portuguese, Russian, Spanish, and more

Upgrade/ Provisioning	Firmware upgrade via TFTP/HTTP/HTTPS/FTP/FTPS, mass provisioning using encrypted XML configuration file, manual upload.
Power & Green Energy Efficiency	Universal power adapter included Input: 100-240VAC; Output: +5VDC, 1A (5W) 2000mA Li-ion battery, 200h standby time and 8h talk time
Physical	Handset dimensions: 164.0 x 52.0 x 25.8mm Charger cradle dimensions: 77.9 x 81.2 x 38.2mm Handset weight: 185.90g Handset package weight (not including QIG): 422.60g
Temperature and Humidity	Operating Temperature: 0°C to 45°C; Operating Humidity: 10-90% (non-condensing) Storage Temperature: -20°C to 60°C; Storage Humidity: 10-90% (non-condensing)
Package Contents	Handset unit, universal power supply, charger cradle, belt clip, 1 Li-ion battery, Quick Start Guide
Compliance	FCC, CE, RCM, IC, UKCA

Table 3: WP822 Technical Specifications

o **WP825**

Protocols/Standards	SIP RFC3261, TCP/IP/UDP, RTP/RTCP, HTTP/HTTPS, ARP, ICMP, DNS (A record, SRV, NAPTR), DHCP, SSH, TFTP, NTP, STUN, SIMPLE, 802.1x, TLS, SRTP, IPv6
Voice Codecs and Capabilities	Support for G.711 μ /a, G.729A/B, G.722 (wide-band), iLBC, Opus, in-band and out-of-band DTMF (In audio, RFC2833, SIP INFO), VAD, CNG, AEC, PLC, AJB, AGC, ANS
Graphic Display	2.4 inch (240x320) TFT color LCD
Peripherals	3 soft keys, dial, hang-up, speakerphone, phonebook, backlit keypad, proximity sensor, vibration motor, volume button, navigation keys, and accelerometer supporting configurable gestures
Push-to-Talk	Customizable button for push-to-talk.
Auxiliary Ports	3.5 mm headset jack, Micro-USB port for charging, dual-MIC, dual-color MWI LED.
Telephony Features	Hold, transfer, forward, 3-way audio conference, call waiting, call log (up to 100 records), downloadable phonebook (XML, up to 500 items) off-hook auto dial, auto answer, flexible dial plan, personalized music ringtones, server redundancy and fail-over, push to talk, LDAP
Security	User and administrator level passwords, MD5 and MD5-sess based authentication, 256-bit AES based secure configuration file, SRTP, TLS, 802.1x media access control
HD Audio	Yes, both on handset and speakerphone with support for wideband audio, HAC supported
QoS	802.11e (WMM) and Layer 3 (ToS, DiffServ, MPLS) QoS
Multi-language	English, Chinese, German, French, Italian, Portuguese, Russian, Spanish, and more
Upgrade/ Provisioning	Firmware upgrade via TFTP/HTTP/HTTPS/FTP/FTPS, mass provisioning using encrypted XML configuration file, manual upload.
Power & Green Energy Efficiency	Universal power adapter included Input: 100-240VAC; Output: +5VDC, 1A (5W)

	2000mA Li-ion battery, 200h standby time and 8h talk time
Physical	Handset dimensions: 164.0 x 52.0 x 25.8mm Charger cradle dimensions: 77.9 x 81.2 x 38.2mm Handset weight: 185.90g Handset package weight (not including QIG): 422.60g
Weatherproof	IP67 Rated -Water-proof, dust-proof, cleaning chemical resistant, anti-microbial casing and 2.5m drop safe
Temperature and Humidity	Operating Temperature: 0°C to 45°C; Operating Humidity: 10-90% (non-condensing) Storage Temperature: -20°C to 60°C; Storage Humidity: 10-90% (non-condensing)
Package Contents	Handset unit, universal power supply, charger cradle, belt clip, 1 Li-ion battery, Quick Start Guide
Compliance	FCC, CE, RCM, IC, UKCA

Table 4: WP825 Technical Specifications

GETTING STARTED

This chapter provides basic installation instructions including the list of the packaging contents and also information for obtaining best performance with the WP810, WP822 and WP825.

Equipment Packaging

WP810/WP822/WP825
<ul style="list-style-type: none"> ● 1x Handset unit ● 1x Universal power supply 5V ● 1x Charging station ● 1x Belt clip ● 1x Rechargeable battery ● 1x Quick Installation Guide

Table 5: Equipment Packaging



1x WP810 Handset

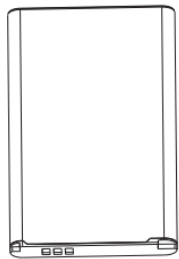

1x Rechargeable Battery



1x Charging Station

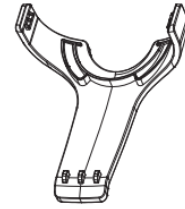

1x Handset Belt Clip



1x 5V Power Adapter



1x Quick Installation Guide

Figure 1: WP810 Package Content

o WP822



1x WP822 Handset

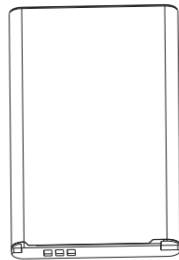

1x Rechargeable Battery



1x Charging Station

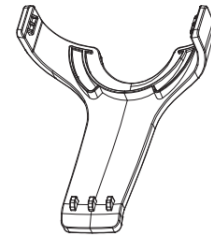

1x Handset Belt Clip



1x 5V Power Adapter

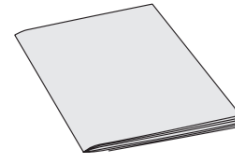

1x Quick Installation Guide

Figure 2: WP822 Package Content

o WP825

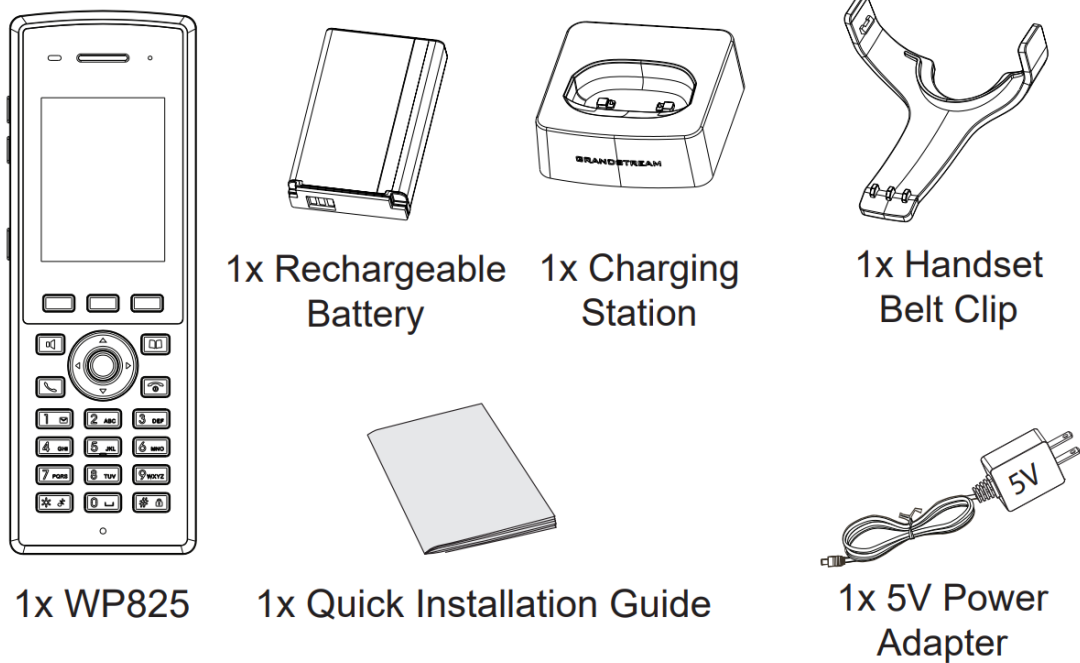

Figure 3: WP825 Package Content

Important

Check the package before installation. If you find anything missing, contact your system administrator.

Setting up the Phone

Charging Station

Plug the power adapter into a power source socket to start using the charging station.

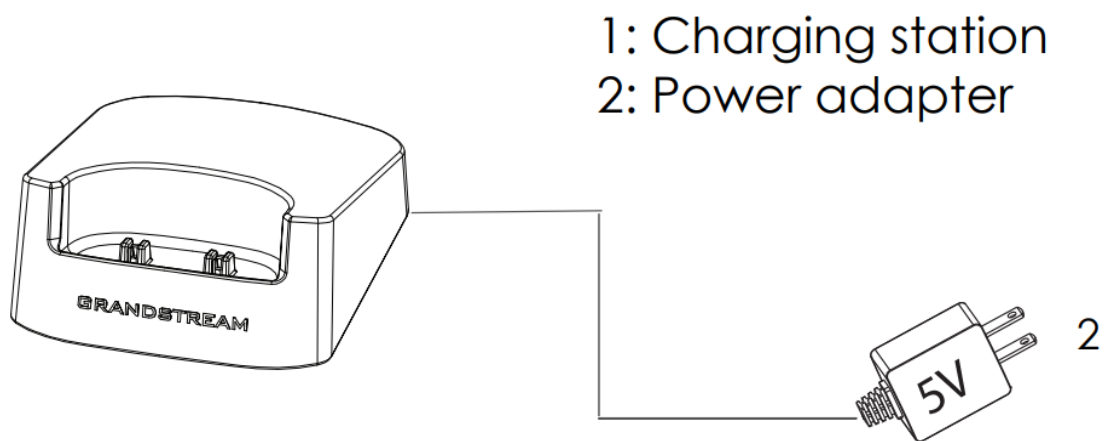

Figure 4: Charging Station

Handset

Please refer to the following steps in order to setup your WP810/WP822/WP825 phone:

1. Open the battery cover.
2. Insert the battery with the electrodes in the bottom left corner.
3. Close the battery cover.

Note

Please charge the battery fully before using the handset for the first time. (For more information about the battery, please refer to **Battery Information**.)

- 1: Battery cover
- 2: Battery
- 3: Rear of handset

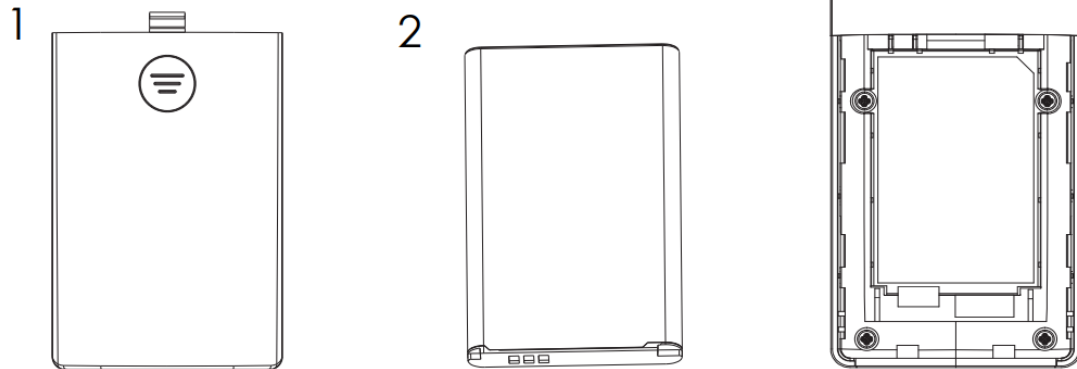

Figure 5: Handset Setup

Battery Information

WP810

- **Technology:** Rechargeable Li-ion Battery
- **Voltage:** 3.8V (Nominal Voltage 3.8V / Limited charge Voltage: 4.35V)
- **Capacity:** 1500mAh
- **Standby time:** up to 120 hours
- **Talk time:** up to 6 hours' active talk time

WP822

- **Technology:** Rechargeable Li-ion Battery
- **Voltage:** 3.8V (Nominal Voltage 3.8V / Limited charge Voltage: 4.35V)
- **Capacity:** 2000mAh
- **Standby time:** up to 200 hours
- **Talk time:** up to 8 hours' active talk time

WP825

- **Technology:** Rechargeable Li-ion Battery
- **Voltage:** 3.8V (Nominal Voltage 3.8V / Limited charge Voltage: 4.35V)
- **Capacity:** 2000mAh
- **Standby time:** up to 200 hours
- **Talk time:** up to 8 hours' active talk time

In order to get the best performance of your WP810/WP822/WP825, we recommend using original battery provided in the package. The specifications may differ depending on the age and capacity of the battery used.

Very Important

Be careful when inserting the battery into your handset to avoid any risk of short-circuit, which lead to damage your battery and/or the handset itself. Do not use damaged batteries which can increase the risk of serious harm.

Handset Keys Description

The WP810/WP822/WP825 Wireless IP phone enhances communication and combines usability and scalability in industries such as warehousing, catering and retail as well as in factory settings. The following screenshot describe the the handsets LCD screen and the main hardware components.

o WP810

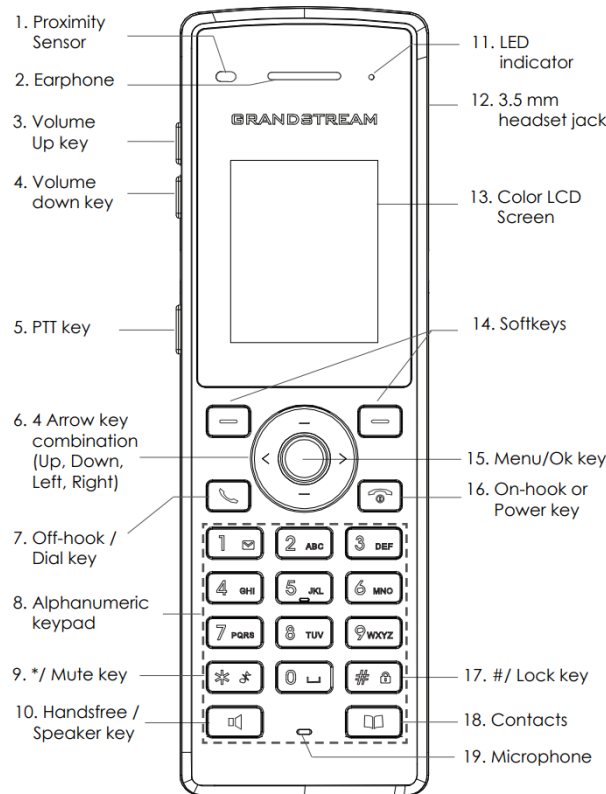

Figure 6: WP810 Description

The following table describe the WP810 keypad keys.

Key	Description
1. Proximity sensor	The proximity sensor can detect and measure gravitational acceleration, tilt, vibration, altitude changes, and static position.
2. Earphone	Delivers audio output.
3, 4. Volume up / Down Keys	Configure the handset and ringtone volume.
5. PTT Key	PTT (Push-to-Talk) button, to initiate PTT call.
6. * / Mute key	Keep pressing on * in idle screen to mute/unmute the ringtone.
7. Arrow key combination (Up, Down, Left, Right)	Allows navigation of the cursor through the displayed menu options.

8.	Off-hook / Dial key	Enters dialing mode, or dials number entered.
9.	Alphanumeric Keypad	Provides the digits, letters, and special characters in context-sensitive applications. For + sign, press and hold key 0.
1 0.	Hands-free / Speaker key	Activates or deactivates the mute feature when keep pressing on * in idle screen.
1 1.	LED indicator	1dual-color LED indicator indicating power, call, battery, message waiting...
1 2.	3.5 mm headset jack	Phone connector for the headphones/headsets.
1 3.	Color LCD Screen	1.8-inch (128×160) color LCD
1 4.	Softkeys	Correspond to functions displayed on the LCD. These functions change depending on the current context.
1 5.	Menu/OK key	Access to contacts list.
1 6.	On-hook or Power key	Selects the option chosen by the cursor or enters the main menu from the home screen.
1 7.	# / Lock key	Terminates calls or turns the handset on / off.
1 8.	Contacts	Locks keypad against unintentional entries when keep pressing #. <ul style="list-style-type: none"> ○ Press and hold # key for approximately 2 seconds to lock the keys. ○ Press Unlock softkey and then # to unlock the keys.
1 9.	Microphone	Picks up audio earpiece and hands-free calls.

Table 6: WP810 keypad keys Description

- WP822

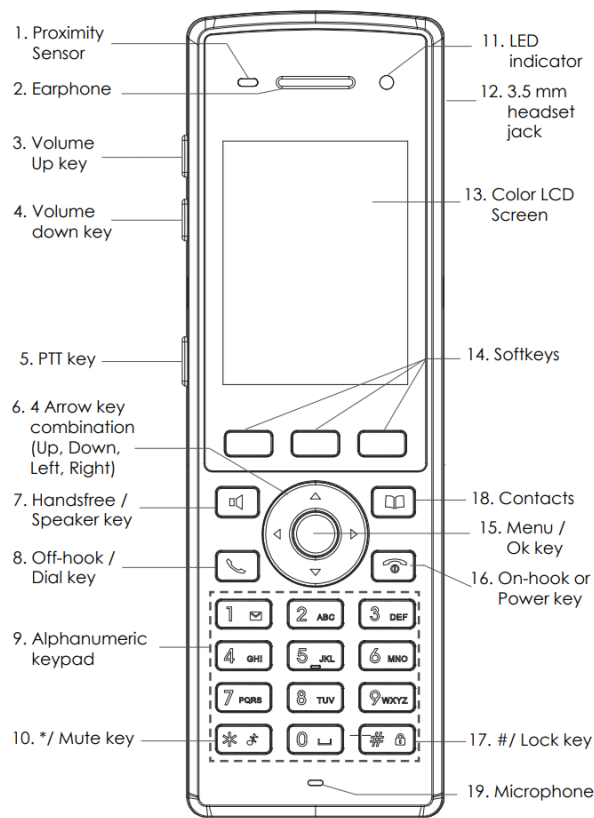

Figure 7: WP822 Description

The following table describe the WP822 keypad keys.

	Key	Description
1.	Proximity sensor	The proximity sensor can detect and measure gravitational acceleration, tilt, vibration, altitude changes, and static position.
2.	Earphone	Delivers audio output.
3, 4	Volume up / Down Keys	Configure the handset and ringtone volume.
5.	PTT Key	PTT (Push-to-Talk) button, to initiate PTT call.
6.	* / Mute key	Keep pressing on * in idle screen to mute/unmute the ringtone.
7.	Arrow key combination (Up, Down, Left, Right)	Allows navigation of the cursor through the displayed menu options.
8.	Off-hook / Dial key	Enters dialing mode, or dials number entered.
9.	Alphanumeric Keypad	Provides the digits, letters, and special characters in context-sensitive applications. For + sign, press and hold key 0.
1 0.	Hands-free / Speaker key	Activates or deactivates the mute feature when keep pressing on * in idle screen.
1 1.	LED indicator	1dual-color LED indicator indicating power, call, battery, message waiting...
1 2.	3.5 mm headset jack	Phone connector for the headphones/headsets.

1 3.	Color LCD Screen	1.8-inch (128×160) color LCD
1 4.	Softkeys	Correspond to functions displayed on the LCD. These functions change depending on the current context.
1 5.	Menu/OK key	Access to contacts list.
1 6.	On-hook or Power key	Selects the option chosen by the cursor or enters the main menu from the home screen.
1 7.	# / Lock key	Terminates calls or turns the handset on / off.
1 8.	Contacts	Locks keypad against unintentional entries when keep pressing #. <ul style="list-style-type: none"> ○ Press and hold # key for approximately 2 seconds to lock the keys. ○ Press Unlock softkey and then # to unlock the keys.
1 9.	Microphone	Picks up audio earpiece and hands-free calls.

Table 7: WP822 keypad keys Description

○ WP825

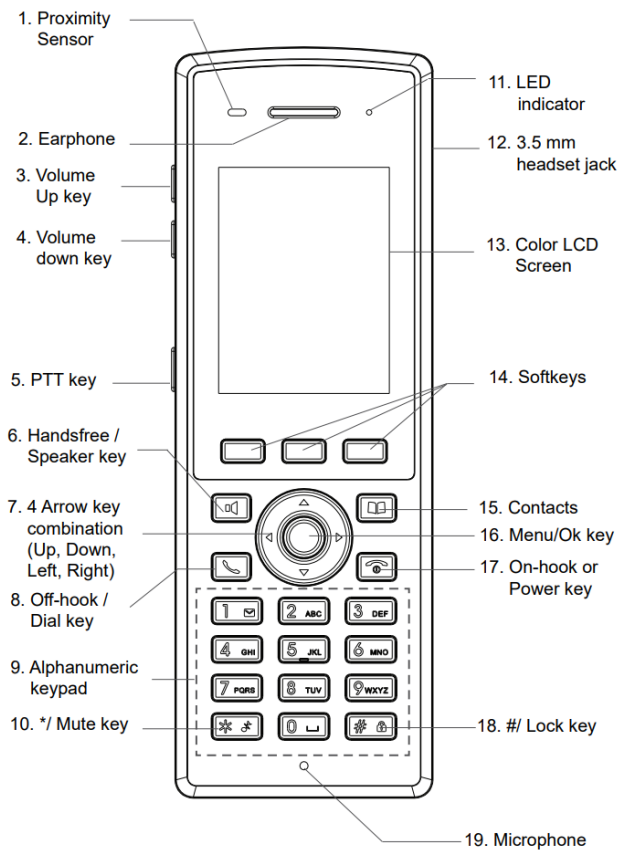

Figure 8: WP825 Description

The following table describe the WP825 keypad keys.

Key	Description
-----	-------------

1.	Proximity sensor	The proximity sensor can detect and measure gravitational acceleration, tilt, vibration, altitude changes, and static position.
2.	Earphone	Delivers audio output.
3, 4	Volume up / Down Keys	Configure the handset and ringtone volume.
5.	PTT Key	PTT (Push-to-Talk) button, to initiate PTT call.
6.	* / Mute key	Keep pressing on * in idle screen to mute/unmute the ringtone.
7.	Arrow key combination (Up, Down, Left, Right)	Allows navigation of the cursor through the displayed menu options.
8.	Off-hook / Dial key	Enters dialing mode, or dials number entered.
9.	Alphanumeric Keypad	Provides the digits, letters, and special characters in context-sensitive applications. For + sign, press and hold key 0.
1 0.	Hands-free / Speaker key	Activates or deactivates the mute feature when keep pressing on * in idle screen.
1 1.	LED indicator	1dual-color LED indicator indicating power, call, battery, message waiting...
1 2.	3.5 mm headset jack	Phone connector for the headphones/headsets.
1 3.	Color LCD Screen	1.8-inch (128×160) color LCD
1 4.	Softkeys	Correspond to functions displayed on the LCD. These functions change depending on the current context.
1 5.	Menu/OK key	Access to contacts list.
1 6.	On-hook or Power key	Selects the option chosen by the cursor or enters the main menu from the home screen.
1 7.	# / Lock key	Terminates calls or turns the handset on / off.
1 8.	Contacts	Locks keypad against unintentional entries when keep pressing #. <ul style="list-style-type: none"> ○ Press and hold # key for approximately 2 seconds to lock the keys. ○ Press Unlock softkey and then # to unlock the keys.
1 9.	Microphone	Picks up audio earpiece and hands-free calls.

Table 8: WP825 keypad keys Description

Icons Description

Following table contains description of each icon that might be displayed on the screen of the WP810/WP822/WP825.

















	Battery status Charging
	Wi-Fi not enabled/configured
	Wi-Fi signal status
	Outgoing Call notification
	Missed Call notification
	Rejected Call notification
	Incoming Call notification
	Mute enabled icon
	DND enabled icon
	SRTP & TLS enabled icon
	Contacts
	SMS
	Call History
	Voice Mail
	Diagnosis
	Settings
	Status

Table 9: Icons Description

Note

SRTP & TLS enabled icon will be displayed only in case signaling and media are both encrypted.

Handset Menu

The handset has an easy-to-use menu structure. Every menu opens a list of options. To open the main menu, unlock first the handset and press “Menu” (softkey in the middle). Press Arrow keys to navigate to the menu option you require. Then press “Select” (left softkey) or **OK/Selection key** to access further options or confirm the setting displayed. To go to the previous menu item, press “Back” (right softkey). You can press **Power** key at any time to cancel and return to standby mode.

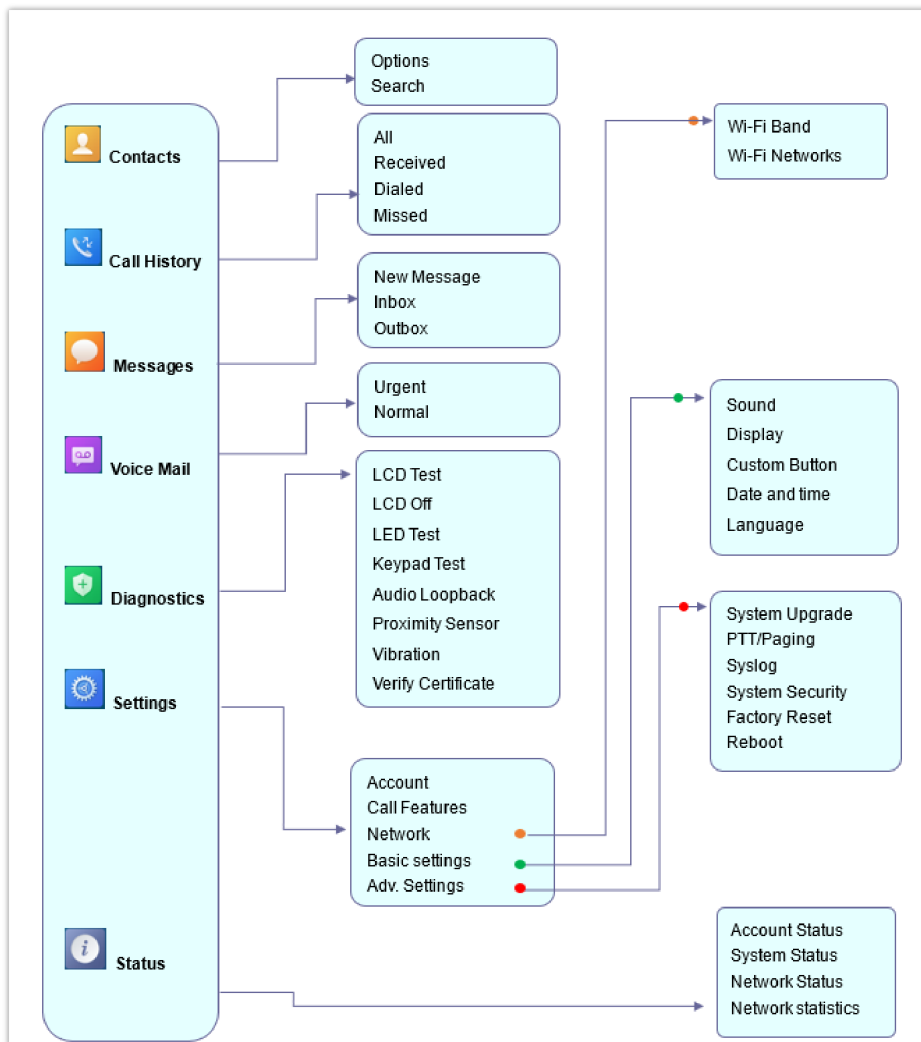

Figure 9: Menu Structure

Contacts	Display the list of the registered contacts and also the groups contacts with the ability of searching, adding or editing the entries and also deleting the selected contacts.
Call History	Display the call history: Missed Calls , Accepted Calls , Outgoing Calls or All Calls . You can add contacts to Shared Contacts directly from call logs.
SMS	SMS stands for Short Message Service and referred to as a “text message”. With a SMS, you can send a message by pressing “ New Message ” of up to 160 characters to another device or check the received ones.
Voice Mail	Select: Play voice mail messages received. Note: Voicemail ID needs to be configured, otherwise, “select” softkeys will open configuration settings.
Diagnostics	<ul style="list-style-type: none"> ● LCD Test ● LCD off

	<ul style="list-style-type: none"> • LED Test • Keypad Test • Audio Loopback • Proximity Sensor • Vibration • Verify Certificate
Settings	<ul style="list-style-type: none"> • Account: Configure/View SIP accounts settings and account ringtone. • Call settings: Configure the account auto answer, call forward, DND and speed dial settings. • Network Settings: Configure the networks settings including Wi-Fi settings, and additional networks settings. • Basic Settings: Configure the basic settings including voice settings, display settings, Gestures and button customization, language settings and date/time settings. • Adv. Settings: Configure the advanced settings including system upgrade, PTT/Paging settings, system security settings, syslog settings and factory reset / reboot.
Status	<p>Displays account status, system info, Network status and network statistics</p> <ul style="list-style-type: none"> • Account status • System Info: Press to enter the sub menu for Running memory, Storage status, MAC address, System version, Recovery version, U-boot version, Kernel version, Hardware version, PN number, Country code and Running time. • Network status: Press to enter the sub menu for MAC address, IP setting information (DHCP/Static IP), IPv4 address, IPv6 address, Subnet Mask, Gateway, DNS server. • Network Statistics: Press to enter the sub menu for Network SSID, BSSID, IP address, Signal strength, Connection speed, Channel, Frequency, Tx packets, Tx error packets, Tx error rate, Tx drop packets, Tx drop rate, Rx packets, Rx error packets, Rx error rate, Rx drop packets, Rx drop rate.

Table 10: Handset Menu

Connecting the handset to Wi-Fi Network

The WP810/WP822/WP825 phone supports dual-band 802.11a/b/g/n/ac Wi-Fi, please refer to the following steps in order to connect your handset to the Wi-Fi networks:

1. On LCD menu, press Menu key and navigate to **Settings → Network**.
2. Select "Wi-Fi Band" (automatic, 2.4GHz or 5GHz) and navigate to "Wi-Fi Networks". A list of Wi-Fi networks will be displayed.
3. Select the desired network to connect to. (Enter the correct password to connect if requested)

The handset will display Wi-Fi icon on the main LCD menu if the connection to the Wi-Fi network is successful.

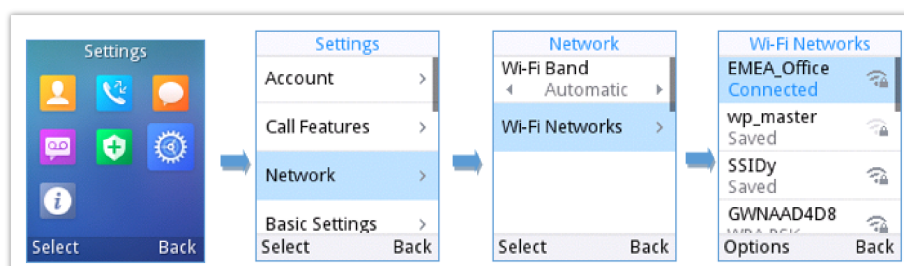



Figure 10: Connecting to Wi-Fi Network

Note

- If 5GHz and 2.4Ghz are both available when "Wi-Fi Band" is set to "Automatic", the WP810/WP822/WP825 will use 5GHz, but it may switch to 2.4GHz if the signal of 5GHz is poor. Users may also specify the Wi-Fi Band in order to fix it or to keep it Dual Band.
- WP810/WP822/WP825 supports connection to Wi-Fi with captive portal enabled that requires additional credentials to sign up or login before it is allowed to use Wi-Fi.

Obtain IP Address

In order to know which IP address is assigned to your handset, please follow below steps:

1. Unlock first your phone and press "**Menu**" (Middle softkey) or **Ok** button to view operation menu.
2. Press Arrow (Up, Down, Left, Right) keys to move the cursor to **Status** icon , then press "**Select**" (left softkey) or **Ok** button.
3. Access **Network Status** menu to obtain the IP address of the WP810/WP822/WP825.

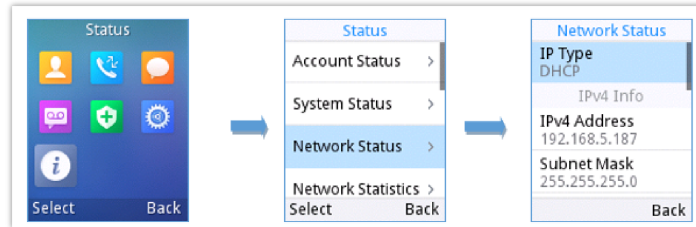

Figure 11: Obtaining IP Address

WEB GUI ACCESS CONFIGURATION

The WP810/WP822/WP825 can be configured using:

- Web GUI embedded on the handset using PC's web browser.
- LCD Configuration Menu using the WP810/WP822/WP825 keypad.

Note

From the Web GUI, you can configure all the functions supported by the WP810/WP822/WP825; while via keypad menu, you can access limited configuration.

Configuration via Web Browser

The WP810/WP822/WP825 embedded Web server responds to HTTP/HTTPS GET/POST requests. Embedded HTML pages allow a user to configure the handset through a Web browser such as Google Chrome, Mozilla Firefox.

Note

Please note that Microsoft's IE 9 and below are not supported, also the records from the web cannot be played with IE10, Edge and Safari. We highly recommend using Google Chrome or Mozilla Firefox.

Accessing the Web UI

1. Connect the computer to the same network as WP810/WP822/WP825.
2. Make sure the handset is booted up and powered correctly.
3. You may check the IP address on the phone LCD menu **Status** → **Network Status**. Please see [Obtain WP810/WP822/WP825 IP Address](#)
4. Open Web browser on your computer and enter the WP810/WP822/WP825 IP address in the address bar of the browser.
5. Enter the administrator's username and password to access the Web Configuration Menu.

Note

- The computer must be connected to the same sub-network as the phone. This can be easily done by connecting the computer to the same hub or switch as the phone.

- The default administrator username is "admin", and the random password can be found on the sticker at the back of the unit. the default end-user username is "user" and the password is "123".
- If 'Web Access' parameter is set to "Disabled" under **Advanced settings** → **System security**; web UI access will be disabled.

Web GUI Languages

Users can select the language in web GUI login page, or at the upper right of the web GUI after logging in.



Figure 12: Web GUI Language login page

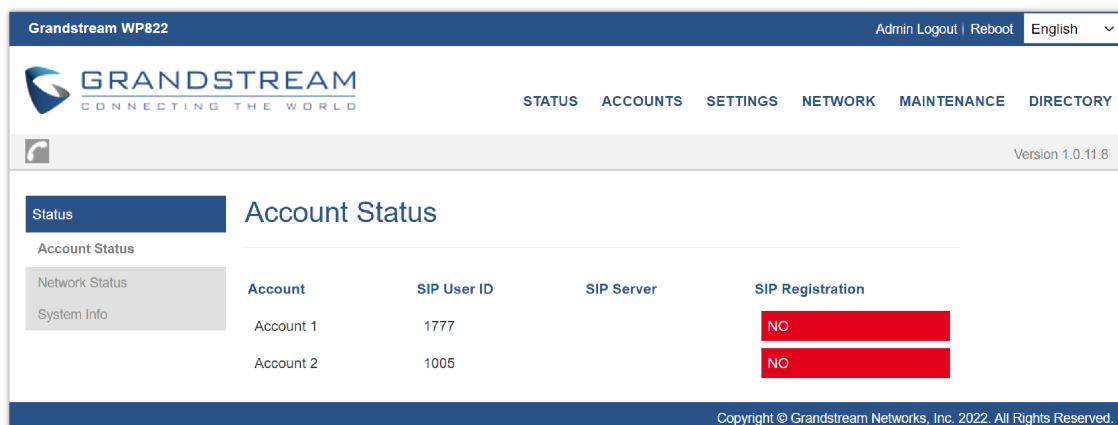

Figure 13: Web GUI Language

Saving the Configuration Changes

When changing any settings, always submit them by pressing **Save** and **Apply** buttons. If using the **Save** button, after making all the changes, click on the **Apply** button on top of the page to submit.

Web UI Access Level Management

There are two default passwords for the login page:

User Level	User Name	Password	Web Pages Allowed
End User Level	user	123	Only Status, Phone Settings, System Settings, Maintenance and System Application with limited options.
Administrator Level	admin	Random password available on the sticker at the back of the unit.	All pages

Table 11: Web UI Access Level

Changing User Level Password

1. Access the Web GUI of your phone using the admin's username and password.
2. Press **Login** to access your settings.
3. Go to **Maintenance** → **Web Access**.
4. locate **User Password** section:
 - Type in your new user password in **New Password** field.
 - Type in again same entered password in **Confirm Password** field.
5. Press **Save** button to save your new settings.

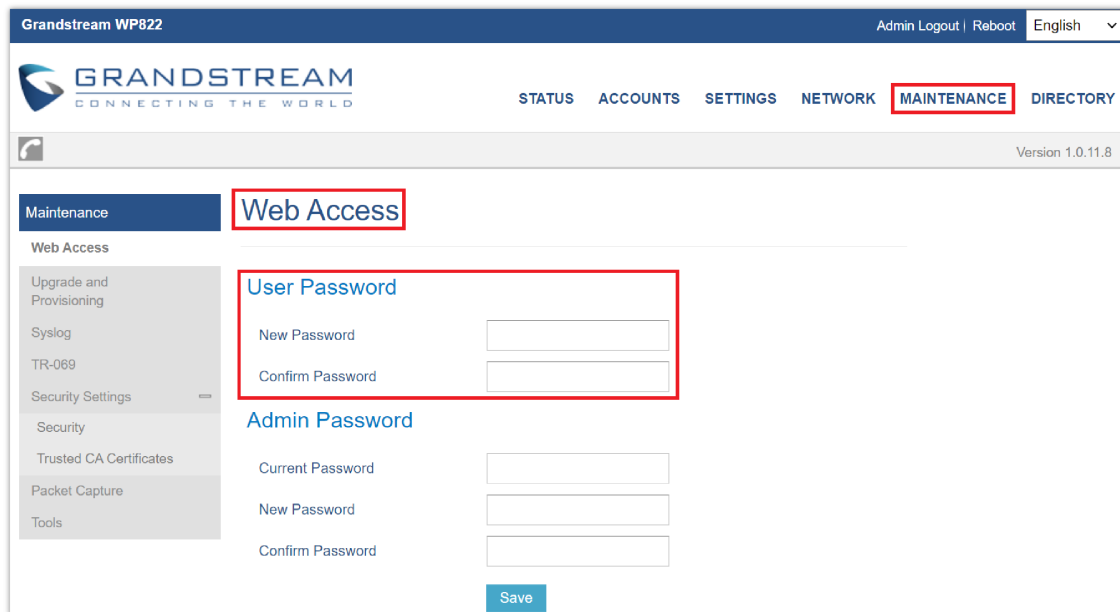

Figure 14: Changing User Level Password

Note

- DO NOT USE same password for both user and admin accounts.
- The password is case sensitive with maximum length of 1 to 512 characters length.

Changing Admin Level Password

1. Access the Web GUI of your WP810/WP822/WP825 using the admin's username and password. (Default username and password is admin/Random Password from the sticker on the back of the unit).
2. Press **Login** to access your settings.

3. Go to **Maintenance** → **Web Access**.
4. locate **Admin Password** section:
 1. Type in the admin password in the **Current Password** field
 2. Type in your new admin password in **New Password** field.
 3. Type in again same entered password in **Confirm Password** field.
5. Press **Save** button to save your new settings.

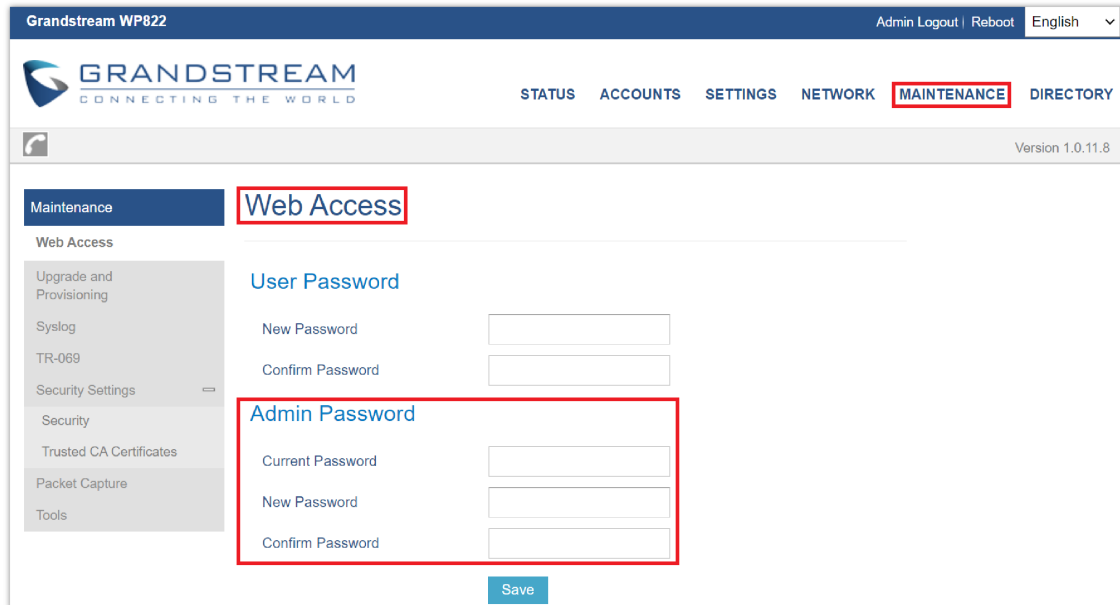

Figure 15: Admin Level Password

Important

- DO NOT USE same password for both user and admin accounts.
- The password is case sensitive with 1 to 512 characters in length.

Changing HTTP/HTTPS Web Access Port

1. Access the Web GUI of your handset using the admin's username and password. (Default username and password are admin/Random password from the sticker on the back of the unit.).
2. Press **Login** to access your settings.
3. Go to **Maintenance** → **Security Settings** → **Security**
4. In **Web Access Mode**, select the access method depending on desired protocol (HTTP or HTTPS or Both)
5. Locate **HTTP / HTTPS Web Port** field and change it to your desired/new HTTP / HTTPS port.
Note: By default, the HTTP port is 80 and HTTPS is 443.
6. Press **Save** button to save your new settings.

Note

After modifying the connection method or port, the web GUI will be automatically logged out and redirected to the new address.

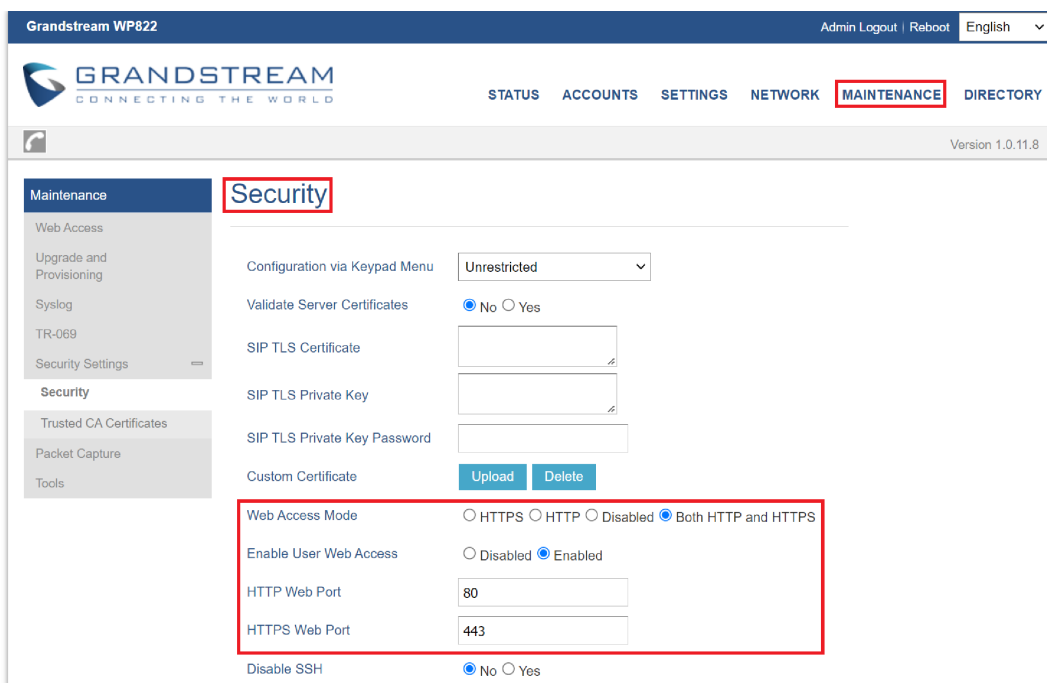

Figure 16: Web Access Port

WEB GUI SETTINGS

This section describes the options in the WP810/WP822/WP825 Web UI. As mentioned, you can log in as an administrator or an end user.

- **Status:** Display account status, network status and system info.
- **Accounts:** Configure accounts with general settings, SIP settings, codec settings, call settings and advanced settings.
- **Settings:** Configure general settings, call settings, ringtone, Video Settings, Multicast paging
- **Network:** Wi-Fi settings, and advanced network settings.
- **Maintenance:** Configure upgrade and provisioning settings and system diagnosis.
- **Directory:** Configure phonebook settings and Call History

Status Page Definitions

Status/Account Status

Account	Displays list of configured accounts.
SIP user ID	Displays the numbers of the configured accounts.
SIP Server	Displays list of SIP Server user by the configured accounts.
SIP Registration	Shows the status of SIP registration. If the SIP account is successfully registered, it will display “Registered” with green background. If the SIP account is not registered, it will display “Unregistered” with grey background.

Table 12: Status/Account Status

Status/Network Status

MAC Address	Shows Device ID in hexadecimal format. This is needed by network administrators for troubleshooting. The MAC address will be used for provisioning and can be found on the label on original box and on the label located on the bottom panel of the device.
IPv4 Address Mode	Indicates the configured address mode: DHCP or Static IP
IPv4 Address	Displays assigned IP address. Example: 192.168.5.110
Subnet Mask	Displays assigned subnet mask. Example: 255.255.255.0
Gateway	Displays assigned default gateway. Example: 192.168.5.1
IPv6 Address Mode	Indicates the configured address mode: DHCP or Static IP
IPv6 Address	Displays assigned IP address.
DNS	Shows assigned DNS server address.
NAT Type	Indicates type of NAT for each Profile. (Based on STUN protocol.)
NAT Traversal	
Account 1	Indicates type of NAT for Account 1.
Account 2	Indicates type of NAT for Account 2.

Table 13: Status/Network Status

Status/System Info

Product Model	Product model of the phone.
Part Number	Product part number.
Software Version	
Boot	Boot code version.
Manifest	Specifies Manifest version.
Core	Specifies Core version.
Base	Specifies Base version.

IP Geographic Information	
Time Zone	Time Zone information
System Time	
System Up Time	System up time since last reboot.
System Time	Shows actual time and date according to your configuration
Service Status	
Gui	Reveals status of GUI
Phone	Reveals status of phone
cpe	Reveals status of Customer Premise Equipment
System Information	
Download System Information	Click to "download" the user's configuration file.
User Space	
User Space Used	Reveals status of user space
Database Status	Reveals status of database
Core Dump	
Generate core dump	Generate core dump by killing program.
Core Dump	Core Dump status
Clear Core Dumps	Click on " Start " to clear all the core dumps

Table 14: Status/System Info

Accounts Page Definitions

Account/General Settings

Account Active	This field indicates whether the account is active. <i>The default setting is "Yes". The default value for Account 2 is "No".</i>
Account Name	Configure the name associated with each account to be displayed on the LCD.
SIP Server	Configures the URL or IP address, and port of the SIP server. This is provided by your VoIP service provider (ITSP).
Secondary SIP Server	Configures the URL or IP address, and port of the SIP server. This will be used when the primary SIP server fails.

Outbound Proxy	Configures the IP address or Domain name of the Primary Outbound Proxy, Media Gateway, or Session Border Controller. It is used by the phone for Firewall or NAT penetration in different network environments. If a symmetric NAT is detected, STUN will not work and ONLY an Outbound Proxy can provide a solution.
Backup Outbound Proxy	IP address or Domain name of the Secondary Outbound Proxy which will be used when the primary proxy cannot be connected.
SIP User ID	Configures the SIP service subscriber's ID used for authentication. It can be identical to or different from the SIP User ID.
Authenticate ID	Configures the account password required for the phone to authenticate with the ITSP (SIP) server before the account can be registered. After it is saved, this will appear as hidden for security purpose.
Authenticate Password	The account password required for the phone to authenticate with the SIP server before the account can be registered.
Name	Configures the SIP server subscriber's name (optional) that will be used for Caller ID display.
Voice Mail Access Number	Defines the voice mail portal access number to allow users accessing their voice messages.
Account Display	When set to "Username", LCD will display Username if it is not empty; When set to "User ID", LCD will display User ID if it is not empty.

Table 15: Account/General Settings

Account/Network Settings

DNS Mode	<p>This parameter controls how the Search Appliance looks up IP addresses for hostnames. There are four modes: A Record, SRV, NATPTR/SRV, Use Configured IP. The default setting is "A Record". If the user wishes to locate the server by DNS SRV, the user may select "SRV" or "NATPTR/SRV".</p> <p>If "Use Configured IP" is selected, please fill in the three fields below:</p> <ul style="list-style-type: none"> • Primary IP. • Backup IP 1. • Backup IP 2. <p>If SIP server is configured as domain name, phone will not send DNS query, but use "Primary IP" or "Backup IP x" to send SIP message if at least one of them are not empty.</p> <p>Phone will try to use "Primary IP" first. After 3 tries without any response, it will switch to "Backup IP x", and then it will switch back to "Primary IP" after 3 re-tries.</p> <p>If SIP server is already an IP address, phone will use it directly even "User Configured IP" is selected</p>
Maximum Number of SIP Request Retries	<p>Specifies the maximum number of retries on SIP Requests.</p> <p>Default Value is 4.</p> <p>The valid Range is between 1-5</p>
DNS SRV Fail-over Mode	<p>The option will decide which IP is going to be used in sending SIP packets after IPs for SIP server host are resolved with DNS SRV.</p> <ul style="list-style-type: none"> • Default: If the option is set with "default", it will again try to send register messages to one IP at a time, and the process repeats. • Saved one until DNS TTL: If the option is set with "Saved one until DNS TTL", it will send register messages to the previously registered IP first. If no response, it will try to send one at a time for each IP. This behavior lasts if DNS TTL (time-to-live) is up. • Saved one until no responses: If the option is set with "Saved one until no responses", it will send register messages to the previously registered IP first, but this behavior will persist until the registered server does not respond. • Saved one until failback timer expires: If set to "Saved one until failback timer expires", previous IP will be applied until the failback timer expires.

Failback Timer	Specifies the time interval (in minutes) that the device should continue to send SIP requests (REGISTER or INVITE) to the failover IP. Once it expires, the SIP requests will be sent to the preferred IP. The default value is 60 minutes, and the max value is 45 days.
Register Before DNS SRV Failover	This option allows to choose the behavior for registering before DNS SRV Fail-over. <ul style="list-style-type: none"> • If set to “No”, a REGISTER request will not be initiated when a server failover occurred under DNS SRV mode. • If set to “Yes”, a REGISTER request will be initiated when a server failover occurred under DNS SRV mode.
Primary IP	Configures the primary IP address where the phone sends DNS query to when “Use Configured IP” is selected for DNS mode.
Backup IP1	Configures the backup IP1 address where the phone sends DNS query to when “Use Configured IP” is selected for DNS mode
Backup IP2	Configures the backup IP2 address where the phone sends DNS query to when “Use Configured IP” is selected for DNS mode
NAT Traversal	This parameter configures whether the NAT traversal mechanism is activated. Users could select the mechanism from No, STUN, Keep-alive, UPnP or Auto. The default setting is “No”. If set to “STUN” and STUN server is configured, the phone will route according to the STUN server. If NAT type is Full Cone, Restricted Cone or Port-Restricted Cone, the phone will try to use public IP addresses and port number in all the SIP&SDP messages. The phone will send empty SDP packet to the SIP server periodically to keep the NAT port open if it is configured to be “Keep-alive”. Configure this to be “No” if an outbound proxy is used. “STUN” cannot be used if the detected NAT is symmetric NAT.
Proxy-Require	Adds the Proxy-Required header in the SIP message. It is used to indicate proxy-sensitive features that must be supported by the proxy. Do not configure this parameter unless this feature is supported on the SIP server.

Table 16: Account/Network Settings

Account/SIP Settings

Basic Settings	
TEL URI	<p>If the phone has an assigned PSTN telephone number, this field should be set to “User=Phone”.</p> <p>Then a “User=Phone” parameter will be attached to the Request-Line and “TO” header in the SIP request to indicate the E.164 number.</p> <p>If set to “Enable”, “Tel:” will be used instead of “SIP:” in the SIP request.</p> <p><i>The default setting is “Disable”.</i></p>
SIP Registration	<p>Selects whether the phone will send SIP Register messages to the proxy/server.</p> <p><i>The default setting is “Yes”.</i></p>
Unregister On Reboot	<p>Allows the SIP user’s registration information to be cleared when the phone reboots. The SIP REGISTER message will contain “Expires: 0” to unbind the connection. Three options are available: <i>The default setting is “No”.</i></p> <ul style="list-style-type: none"> • If set to “All”, the SIP user’s registration information will be cleared when the phone reboots. The SIP Contact header will contain “*” to notify the server to unbind the connection. • If set to “Instance”, the SIP user will be unregistered on current phone only. • If set to “No”, the phone will not unregister the SIP account when rebooting.
Register Expiration	<p>Specifies the frequency (in minutes) in which the phone refreshes its registration with the specified registrar. The default value is 60 minutes.</p> <p><i>The maximum value is 64800 minutes (about 45 days).</i></p>

Subscribe Expiration	Specifies the frequency (in minutes) in which the phone refreshes its subscription with the specified registrar. The maximum value is 64800 (about 45 days). <i>The default value is 60 minutes.</i>
Reregister Before Expiration	Specifies the time frequency (in seconds) that the phone sends re-registration request before the Register Expiration. <i>The default value is 0.</i>
Enable OPTIONS Keep Alive	Enable OPTIONS Keep Alive to check SIP Server.
OPTIONS Keep Alive Interval	Time interval for OPTIONS Keep Alive feature in Second.
OPTIONS Keep Alive Max Lost	Number of max lost packets for OPTIONS Keep Alive feature before the phone re-registration.
Enable TCP Keep Alive	Enable TCP keep alive for the respective SIP account when the account protocol uses TCP/TLS. <i>The default setting is "No".</i>
Local SIP Port	Defines the local SIP port used to listen and transmit. The default value is 5060 for Account 1, 5062 for Account 2, 5064 for Account 3, 5066 for Account 4, 5068 for Account 5, 5070 for Account 6. <i>The valid range is from 1 to 65535.</i>
SIP Registration Failure Retry Wait Time	Specifies the interval to retry registration if the process is failed. The valid range is 1 to 3600. <i>The default value is 20 seconds.</i>
SIP T1 Timeout	SIP T1 Timeout is an estimate of the round-trip time of transactions between a client and server. If no response is received the timeout is increased and request re-transmit retries would continue until a maximum amount of time define by T2. <i>The default setting is 0.5 seconds.</i>
SIP T2 Timeout	SIP T2 Timeout is the maximum retransmit time of any SIP request messages (excluding the INVITE message). The re-transmitting and doubling of T1 continues until it reaches the T2 value. <i>Default is 4 seconds.</i>
SIP Timer B Timeout	Timer B is the maximum amount of time that a sender will wait for an INVITE message to be acknowledged. Default value is 0. The range must be between 0, 2-128
SIP Timer F Timeout	Timer F is the maximum amount of time that a sender will wait for a non INVITE message to be acknowledged. Default value is 0. The valid range is 0-128 s
SIP Transport	Determines the network protocol used for the SIP transport. Users can choose from TCP, UDP and TLS. <i>The default setting is "UDP".</i>
SIP Listening Mode	Based on option "SIP Transport" and this option "SIP Listening Mode", phone will decide which transport protocol it should listening to from the incoming request. <i>The default setting is "Transport Only".</i> <ul style="list-style-type: none"> ● Transport Only ● Dual ● Dual (Secured) ● Dual (BLF Enforced)

SIP URI Scheme when using TLS	Specifies if “sip” or “sips” will be used when TLS/TCP is selected for SIP Transport. <i>The default setting is “sips”.</i>
Use Actual Ephemeral Port in Contact with TCP/TLS	This option is used to control the port information in the Via header and Contact header. If set to No, these port numbers will use the permanent listening port on the phone. Otherwise, they will use the ephemeral port for the connection. <i>The default setting is “No”.</i>
Outbound Proxy Mode	The Outbound proxy mode is placed in the route header when sending SIP messages, or they can be always sent to outbound proxy.
Support SIP Instance ID	Defines whether SIP Instance ID is supported or not. <i>Default setting is “Yes”.</i>
SUBSCRIBE for MWI	When set to “Yes”, a SUBSCRIBE for Message Waiting Indication will be sent periodically. The phone supports synchronized and non-synchronized MWI. <i>The default setting is “No”.</i>
SUBSCRIBE for Registration	When set to “Yes”, a SUBSCRIBE for Registration will be sent out periodically. <i>The default setting is “No”.</i>
Enable 100rel	The use of the PRACK (Provisional Acknowledgment) method enables reliability to SIP provisional responses (1xx series). This is very important to support PSTN internetworking. To invoke a reliable provisional response, the 100rel tag is appended to the value of the required header of the initial signaling messages. <i>The default setting is “No”.</i>
Callee ID Display	When set to “Auto”, the phone will update the callee ID in the order of P-Asserted Identity Header, Remote-Party-ID Header and To Header in the 180 Ringing. If “Disabled”, callee ID will be displayed as “Unavailable”. When set to “To Header”, caller ID will not be updated and displayed as To Header.
Caller ID Display	When set to “Auto”, the phone will look for the caller ID in the order of P-Asserted Identity Header, Remote-Party-ID Header and From Header in the incoming SIP INVITE. When set to “Disabled”, all incoming calls are displayed with “Unavailable”. When set to “From Header”, the phone will display the caller ID based on the From Header in the incoming SIP INVITE. <i>The default setting is “Auto”.</i>
Add Auth Header on Initial REGISTER	To define whether authorization Header will be added on initial REGISTER from the first REGISTER. <i>The default setting is “No”.</i>
Allow SIP Reset	This is used to perform a factory reset through SIP NOTIFY. When the phone receives the NOTIFY with event: RESET, the phone should perform a factory reset after the authentication. <i>The default setting is “No”.</i>
Ignore Alert-Info header	This option is used to configure default ringtone. If set to “Yes”, configured default ringtone will be played. <i>The default setting is “No”.</i>
Custom SIP Headers	
Use Privacy Header	Controls whether the Privacy header will present in the SIP INVITE message or not, whether the header contains the caller info. When set to “Default”, the Privacy Header will show in INVITE only when “Huawei IMS” special feature is on. If set to “Yes”, the Privacy Header will always show in INVITE. If set to “No”, the Privacy Header will not show in INVITE. <i>Default setting is “Default”.</i>
Use P-Preferred- Identity Header	Controls whether the P-Preferred-Identity Header will present in the SIP INVITE message. The default setting is “default”: The P-Preferred-Identity Header will show in INVITE unless “Huawei IMS” special feature is on. If set to “Yes”, the P-Preferred-Identity Header will always show in INVITE.

	If set to "No", the P-Preferred-Identity Header will not show in INVITE.
Use P-Access-Network-Info Header	Enables / disables the use of P-Access-Network-Info header in SIP request. When disabled, the SIP message sent from the phone will not include the selected header. <i>Default setting is "No".</i>
Use P-Emergency-Info Header	Enables / disables the use of P-Emergency-Info header in SIP request. When disabled, the SIP message sent from the phone will not include the selected header. <i>Default setting is "No".</i>
Use MAC Header	If set to " Only for REGISTER ", only the SIP message for register and unregister will contain the MAC header. If set to " Yes to All SIP ", all the outgoing SIP messages will contain the MAC header. If set to " No ", MAC header will not be contained in any outgoing SIP message.
Add MAC in User-Agent	If set to " Yes except REGISTER ", all outgoing SIP messages will include the phone's MAC address in the User-Agent header, except for REGISTER and UNREGISTER. If set to " Yes to All SIP ", all outgoing SIP messages will include the phone's MAC address in the User-Agent header. If set to " No ", the phone's MAC address will not be included in the User-Agent header in any outgoing SIP messages.
Advanced Features	
PUBLISH for Presence	Enables Presence feature on the phone.
Omit charset=UTF-8 in MESSAGE	Omit charset=UTF-8 in MESSAGE content-type
Feature Key Synchronization	When enabled, DND and Call Forward features can be synchronized with Broadsoft server. Note: When using this feature, Special Feature needs to be set to BroadSoft. <i>Default is "Disabled"</i>
Special Feature	Different soft switch vendors have special requirements. Therefore, users may need select special features to meet these requirements. Users can choose from Standard, Nortel MCS, Broadsoft, CBCOM, RNK, Sylantro, Huawei IMS, PhonePower and UCM Call center depending on the server type. <i>The default setting is "Standard".</i>
Session Timer	
Enable Session Timer	This option is used to enable or disable session timer on the phone side. <i>The default setting is "No".</i>
Session Expiration	The SIP Session Timer extension (in seconds) that enables SIP sessions to be periodically "refreshed" via a SIP request (UPDATE, or re-INVITE). If there is no refresh via an UPDATE or re-INVITE message, the session will be terminated once the session interval expires. Session Expiration is the time (in seconds) where the session is considered timed out, provided no successful session refresh transaction occurs beforehand. <i>The default setting is 180. The valid range is from 90 to 64800.</i>
Min-SE	The minimum session expiration (in seconds). The default value is 90 seconds. <i>The valid range is from 90 to 64800.</i>
Caller Request Timer	If set to "Yes" and the remote party supports session timers, the phone will use a session timer when it makes outbound calls. <i>The default setting is "No".</i>
Callee Request Timer	If set to "Yes" and the remote party supports session timers, the phone will use a session timer when it

	receives inbound calls. <i>Default setting is "No"</i> .
Force Timer	If Force Timer is set to "Yes", the phone will use the session timer even if the remote party does not support this feature. If Force Timer is set to "No", the phone will enable the session timer only when the remote party supports this feature. To turn off the session timer, select "No". <i>The default setting is "No"</i> .
UAC Specify Refresher	As a Caller, select UAC to use the phone as the refresher; or select UAS to use the Callee or proxy server as the refresher. <i>The default setting is "Omit"</i> .
UAS Specify Refresher	As a Callee, select UAC to use caller or proxy server as the refresher; or select UAS to use the phone as the refresher. <i>The default setting is "UAC"</i> .
Force INVITE	The Session Timer can be refreshed using the INVITE method or the UPDATE method. Select "Yes" to use the INVITE method to refresh the session timer. <i>The default setting is "No"</i> .
Security Settings	
Check Domain Certificates	Choose whether the domain certificates will be checked or not when TLS/TCP is used for SIP Transport. <i>The default setting is "No"</i> .
Validate Certificate Chain	Validate certification chain when TCP/TLS is configured. <i>Default setting is "No"</i> .
Validate Incoming Messages	Choose whether the incoming messages will be validated or not. <i>The default setting is "No"</i> .
Check SIP User ID for Incoming INVITE	If set to "Yes", SIP User ID will be checked in the Request URI of the incoming INVITE. If it does not match the phone's SIP User ID, the call will be rejected. <i>The default setting is "No"</i> .
Accept Incoming SIP from Proxy Only	When set to "Yes", the SIP address of the Request URL in the incoming SIP message will be checked. If it does not match the SIP server address of the account, the call will be rejected. <i>The default setting is "No"</i> .
Authenticate Incoming INVITE	If set to "Yes", the phone will challenge the incoming INVITE for authentication with SIP 401 Unauthorized response. <i>Default setting is "No"</i> .

Table 17: Account/SIP Settings

Account/Audio Settings

Preferred Vocoder	Multiple vocoder types are supported on the phone, the vocoders in the list is a higher preference. Users can configure vocoders in a preference list that is included with the same preference order in SDP message.
Use First Matching Vocoder in 200OK SDP	When it is set to "Yes", the device will use the first matching vocoder in the received 200OK SDP as the codec. The default setting is "No".
Codec Negotiation Priority	Configures the phone to use which codec sequence to negotiate as the callee. When set to "Caller", the phone negotiates by SDP codec sequence from received SIP Invite. When set to "Callee", the phone negotiates by audio codec sequence on the phone. The default setting is "Callee".

Disable Multiple m line in SDP	When it is set to "No", the device will reply with multiple m lines; Otherwise, it will reply 1 m line. The default setting is "No".
SRTP Mode	Enable SRTP mode based on your selection from the drop-down menu. The default setting is "Disabled".
SRTP Key Length	Allows users to specify the length of the SRTP calls. The available options are AES 128&256 bit, AES 128 bit and AES 256 bit. Default setting is AES 128&256 bit
Crypto Lifetime	Enable or disable the crypto lifetime when using SRTP. If users set to disable this option, phone does not add the crypto lifetime to SRTP header. The default setting is "Yes".
Symmetric RTP	Defines whether symmetric RTP is supported or not. Default setting is "No".
Silence Suppression	Controls the silence suppression/VAD feature of the audio codecs except for G.723 (pending) and G.729. If set to "Yes", a small quantity of RTP packets containing comfort noise will be sent during the periods of silence. If set to "No", this feature is disabled. Default setting is "No"
Jitter Buffer Type	Selects either Fixed or Adaptive for jitter buffer type, based on network conditions. The default setting is "Adaptive".
Jitter Buffer Length	Selects jitter buffer length from 100ms to 800ms, based on network conditions. The default setting is "300ms".
Voice Frames Per TX	Configures the number of voice frames transmitted per packet. When configuring this, it should be noted that the "ptime" value for the SDP will change with different configurations here. This value is related to the codec used and the actual frames transmitted during the in-payload call. For end users, it is recommended to use the default setting, as incorrect settings may influence the audio quality. The default setting is 2.
G.726-32 Packing Mode	Selects "ITU" or "IETF" for G726-32 packing mode. The default setting is "ITU".
iLBC Frame Size	This option determines the iLBC packet frame size. Users can choose from 20ms and 30ms. The default setting is "30ms".
iLBC Payload Type	This option is used to specify iLBC payload type. Valid range is 96 to 127. The default setting is "97".
OPUS Payload Type	Specifies OPUS payload type. Valid range is 96 to 127. Cannot be the same as iLBC or DTMF Payload Type. Default value is 123.
DTMF Payload Type	Configures the payload type for DTMF using RFC2833. Cannot be the same as iLBC or OPUS payload type.

Send DTMF	<p>This parameter specifies the mechanism to transmit DTMF digits. There are 3 supported modes:</p> <ul style="list-style-type: none"> • In audio: DTMF is combined in the audio signal (not very reliable with low-bit-rate codecs). • RFC2833 sends DTMF with RTP packet. Users can check the RTP packet to see the DTMFs sent as well as the number pressed. • SIP INFO uses SIP INFO to carry DTMF. <p>Default setting is "RFC2833".</p>
------------------	-------------------------------------------------------------------------------------------------------------------------------------------------------------------------------------------------------------------------------------------------------------------------------------------------------------------------------------------------------------------------------------------------------------------------------------------------------------------------------

Table 18: Account/Audio Settings

Account/Call Settings

Dial Plan	Configures the dial plan rule. For syntax and examples, please refer to user manual for more details.
Bypass Dial Plan	Select where to bypass the dial plan
Call Log	Configures Call Log setting on the phone. You can log all calls, only log incoming/outgoing calls (missed calls will not be logged) or disable call log. The default setting is "Log All Calls".
Send Anonymous	If set to "Yes", the "From" header in outgoing INVITE messages will be set to anonymous, blocking the Caller ID to be displayed. Default is "No".
Anonymous Call Rejection	<p>If set to "Yes", anonymous calls will be rejected.</p> <p>The default setting is "No".</p>
Auto Answer	If set to "Yes", the phone will automatically turn on the speaker phone to answer incoming calls after a short reminding beep. Default setting is "No".
Refer-To Use Target Contact	If set to "Yes", the "Refer-To" header uses the transferred target's Contact header information for attended transfer. The default setting is "No".
Transfer on Conference Hangup	Defines whether the call is transferred to the other party if the conference initiator hangs up.
Disable Recovery on Blind Transfer	Disable recovery to the call to the transferee on failing blind transfer to the target.
Blind Transfer Wait Timeout	Defines the timeout (in seconds) for waiting SIP frag response in blind transfer. Valid range is 30 to 300.
No Key Entry Timeout	Defines the timeout (in seconds) for no key entry. If no key is pressed after the timeout, the digits will be sent out.
Key As Send	Pressing selected key will immediately dial out.
Disable Key As Send Redial	Disables the redial function of the Key As Send key.
RFC2543 Hold	Allows users to toggle between RFC2543 hold and RFC3261 hold. RFC2543 hold (0.0.0.0) allows user to disable the hold music sent to the other side. RFC3261 (a line) will play the hold music to the other side.

Disable Call Waiting	Enables / disables the call waiting feature for the current account. When set to "Default", global call feature setting will be used. Default setting is Default.
Ringtone	
Account Ringtone	Configures the Account ringtone from a dropdown list that contains multiple ringtone options. Default value is "Default Ringtone".
Match Incoming Caller ID	<p>Specifies matching rules with number, pattern, or Alert Info text (up to 3 matching rules). When the incoming caller ID or Alert Info matches the rule, the phone will ring with selected distinctive ringtone. Matching rules:</p> <ul style="list-style-type: none"> Specific caller ID number. For example, 8321123. A defined pattern with certain length using x and + to specify, where x could be any digit from 0 to 9. Samples: <ul style="list-style-type: none"> xx+: at least 2-digit number. xx: only 2-digit number. [345]xx: 3-digit number with the leading digit of 3, 4 or 5. [6-9]xx: 3-digit number with the leading digit from 6 to 9. Alert Info text: Users could configure the matching rule as certain text (e.g., priority) and select the custom ring tone mapped to it. The custom ring tone will be used if the phone receives SIP INVITE with Alert-Info header in the following format: Alert-Info: <http://127.0.0.1>; info=priority <p>When the incoming caller ID or Alert Info matches one of the 10 rules, the phone will ring with the associated ringtone</p>
Ring Timeout	Defines the timeout (in seconds) for the rings on no answer. The default setting is 60. The valid range is from 10 to 300.

Table 19: Account/Call Settings

Account/Intercom Settings

Allow Auto Answer by Call-Info/Alert-Info	If set to "Yes", the phone will automatically turn on the speaker phone to answer incoming calls after a short reminding beep, based on the SIP Call-Info/Alert-Info header sent from the server/proxy.
Allow Barging by Call-Info/Alert-Info	When enabled, the phone will automatically put the current call on hold and answer the incoming calls based on the SIP Call-Info/Alert-Info header sent from the server/proxy. However, if the current call was answered based on the SIP Call-Info/Alert-Info header, then all other incoming calls with SIP Call-Info/Alert-Info headers will be rejected automatically.
Custom Alert-Info for Auto Answer	Used exclusively to match the contents of the Alert-Info header for auto answer. The default auto answer headers will not be matched if this is defined.

Table 20: Account/Intercom Settings

Account/Feature Codes

Enable Local Call Features	<p>When enabled, Do Not Disturb, Call Forwarding and other call features can be used via the local feature codes on the phone. Otherwise, the provisioned feature codes from the server will be used. User configured feature codes will be used only if server provisioned feature codes are not provided. And once feature codes are configured, either via server provisioning or local setting, a Softkey named “Features” will show on the LCD screen.</p> <p><i>Note: If the device is registered with Broadsoft account, it doesn't matter if local call features are enabled or disabled, once the Broadsoft account is set, special feature to Broadsoft and Feature Key Synchronization is enabled, the call feature will be handled by Broadsoft server, not by the phone.</i></p>
----------------------------	-----------------------------------------------------------------------------------------------------------------------------------------------------------------------------------------------------------------------------------------------------------------------------------------------------------------------------------------------------------------------------------------------------------------------------------------------------------------------------------------------------------------------------------------------------------------------------------------------------------------------------------------------------------------------------------------------------------------------------------------------------------------------------------------------

Table 21: Account/Feature Codes

Account Swap

Swap Account Settings	Swap configurations between two accounts
-----------------------	------------------------------------------

Table 22: Account Swap

Settings Page Definitions

Settings/General Settings

Local RTP Port	Defines local RTP port used to listen and transmit RTP packets.
Local RTP Port Range	This parameter defines the range of local RTP port from 48 to 10000.
Use Random Port	<p>Forces the phone to use random ports for both SIP and RTP messages. This is usually necessary when multiple phones are behind the same full cone NAT. The default setting is “No”.</p> <p>Note: This parameter must be set to “No” for Direct IP Calling to work.</p>
Keep-alive Interval (s)	Specifies how often the phone will send a Binding Request packet to the SIP server in order to keep the “ping hole” on the NAT router to open. The valid range is from 10 to 160. The default setting is 20 seconds.
Use NAT IP	Configures the IP address for the Contact header and Connection Information in the SIP/SDP message. It should ONLY be used if it is required by your ITSP. The default setting is keeping the box blank.
STUN server	The IP address or Domain name of the STUN server. Only non-symmetric NAT routers work with STUN.
Delay Registration	Configures specific time that the account will be registered after booting up.
Test Password Strength	<p>Only Allow password with some constraints to ensure better security.</p> <p>Password needs at least 9 characters and 3 of the following options:</p> <ul style="list-style-type: none"> numerics (0-9) capital letters (A-Z) lower case (a-z) special characters ('./`@*-=, &?!%()~_#')
Allow Dial Through Popups	Allows user to dial DMTF through Popups.

Table 23: Settings/General Settings

Settings/External Service

Service Type	Select the door system service type from the drop-down list. <i>Example : GDS</i>
Account	Select which account to be linked to this service.
System Identification	Enter a System Identification
System Number	Configures the number of the door system. When a call number is the system number, the open door button will be displayed on LCD.
Access Password	Configures the access password of the door system. This password corresponds to the system number. When a call comes from the door system, tap on the open button on LCD to send the password to the corresponding door system.

Table 24: Settings/External Service

Settings/Call Features

Off-hook Auto Dial	Enter the digits to be dialed via the first account when the phone is off-hook.
Off-hook Auto Dial Delay	Defines the timeout (in seconds) for off-hook auto dial. <i>Note: Valid range is 0-10. If set to 0, it will be dialed out immediately; If set to other values, it will be dialed out after the delay.</i>
Disable Call Waiting	Disables the call waiting feature. <i>The default setting is "No".</i>
Disable Direct IP Call	Disables Direct IP Call. <i>The default setting is "No".</i>
Disable in-call DTMF Display	When set to "Yes", the DTMF digits entered during the call will not display.
Enable Live DialPad	If Live DialPad is enabled, the phone will automatically dial out and turns on handsfree mode as soon as a dial pad key or softkey is pressed. Disabled by Default.
Live DialPad Expire Time	Sets the Live Dialpad expiration time, the interval is between 2s and 15s, Default value is 5s
Contact Name Format	Chooses whether to use the first name last name format for a contact's name, or vice versa, with the last name coming before the first. Lastname, Firstname is the standard.
Enable DND Feature	Enables or disables the DND feature, if set to "No", a user cannot turn on the Do Not Disturb feature via the MUTE key, MPK, or menu on LCD. The default value is "No".
Do Not Escape # as %23 in SIP URI	Specifies whether to replace # by %23 or not for some special situations. <i>The default setting is "No".</i>

Return Code When Refusing Incoming Call	When refusing the incoming call. The phone will send the selected type of SIP message of the call. <i>Default setting is "Busy 486".</i>
Return Code When Enable DND	When DND is enabled, the phone will send the selected type of SIP message. <i>Default setting is "Busy 486".</i>
Allow Incoming Call Before Ringing	This allows incoming calls after dialed but before ringing. This can be used under custom user configuration based on need. <i>Default setting is No.</i>
User-Agent Prefix	Configure the prefix in the User-Agent header.
Auto Answer Delay	Configure the delay for automatically answering the incoming call. <i>Valid range is 0 to 10 (second).</i>
Off-cradle Pickup	Enable the Off-cradle Pickup feature to automatically answer incoming calls after picking up WP810/WP822/WP825 Handset from its cradle.
Disable Call End Tone	Configure the toggle of prompt tone when the call is ended.

Table 25: Settings/Call Features

Settings/Multicast Paging

Multicast Paging	Click to disable or enable Multicast paging
Allowed In DND Mode	Allow Multicast paging when DND Mode is enabled
Paging Barge	During active call if incoming multicast page is higher priority (1 being the highest) than this value the call will be held, and multicast page will be played.
Paging Priority Active	If enabled, during a multicast page if another multicast is received with higher priority (1 being the highest) that one will be played instead.
Multicast Paging Codec	Select from the drop list the codec to be used with Multicast Paging
Multicast Sender ID	Outgoing caller ID that displays to your page group recipients(for multicast channel 1 – 50).
Multicast Listening	Defines multicast listening addresses and labels. For example: <ul style="list-style-type: none"> ○ "Listening Address" should match the sender's Value such as "237.11.10.11:6767" ○ "Label" could be the description you want to use.

Table 26: Settings/Multicast Paging

Settings/Preferences

Audio Control	
Speaker Ring Volume	The user may be able to adjust the speaker ring loudness using this feature. The range is between 0 and 7. The Default value is 5.

Lock Speaker Volume	The user could set up this function to lock the speaker volume in either talk mode or ring mode or both. Adjusting the Lock volume can be done when the option is active. The default value is set to "No".
Headset	
Headset Noise Shield 2.0	The Noise Shield feature for Headset creates a virtual "noise shield" which blocks the sounds outside. When the value is set to "high" power, the shield is created closer to the user which filters more noise. When the value is set to "low" power, the shield is created further from the user which filters less noise.
Headset TX Gain (dB)	Configures the transmission gain of the headset. The default is 0dB, and valid range is -6 to 6 dB
Headset RX Gain (dB)	Configures the receiving gain of the headset. The default is 0dB, and valid range is -6 to 6 dB
Handset	
Handset Noise Shield 2.0	The Noise Shield feature for Handset creates a virtual "noise shield" which blocks the sounds outside. When the value is set to "high" power, the shield is created closer to the user which filters more noise. When the value is set to "low" power, the shield is created further from the user which filters less noise.
Handset TX Gain (dB)	Configures the transmission gain of the handset, it can be set to 0, 6, or -6 dB The default is 0dB.
Date and Time	
NTP Server	Defines the URL or IP address of the NTP server. The phone may obtain the date and time from the server. <i>The default setting is "pool.ntp.org".</i>
Secondary NTP Server	Defines the URL or IP address of the NTP server. The phone may obtain the date and time from the server. Allow user to configure 2 NTP servers.
NTP Update Interval	Time interval for updating time from the NTP server. Valid time value is in between 5 to 1440 minutes. <i>The default setting is "1440" minutes.</i>
Allow DHCP Option 42 to override NTP server	Defines whether DHCP Option 42 should override NTP server or not. When enabled, DHCP Option 42 will override the NTP server if it is set up on the LAN. <i>The default setting is "Yes".</i>
Time Zone	Configures the date/time used on the phone according to the specified time zone.
Allow DHCP Option 2 to Override Time Zone Setting	Allows device to get provisioned for Time Zone from DHCP Option 2 in the local server.
Self-Defined Time Zone	This parameter allows the users to define their own time zone. The syntax is: std offset dst [offset], start [/time], end [/time] Default is set to: MTZ+6MDT+5, M4.1.0, M11.1.0 MTZ+6MDT+5 This indicates a time zone with 6 hours offset with 1 hour ahead (when daylight saving) which is U.S central time. If it is positive (+) if the local time zone is west of the Prime Meridian (A.K.A: International or Greenwich Meridian) and negative (-) if it is east. M4.1.0, M11.1.0 The 1st number indicates Month: 1,2,3..., 12 (for Jan, Feb, ..., Dec) The 2nd number indicates the nth iteration of the weekday: (1st Sunday, 3rd Tuesday...)

	<p>The 3rd number indicates weekday: 0,1, 2,...,6 (for Sun, Mon, Tue, ... ,Sat)</p> <p>Therefore, this example is the DST which starts from the First Sunday of April to the 1st Sunday of November.</p>
Date Display Format	Configures the date display format on the LCD.
Time Display Format	Configures the time display in 12-hour or 24-hour format on the LCD. <i>The default setting is in 12-hour format.</i>
Language	
Display Language	Selects display language on the phone. <i>Default is English.</i>
Wallpaper	
Wallpaper Source	Configures the location where wallpapers are stored, the options are "Default", "Download", "Uploaded" Default value is "Default"
Wallpaper Server Path	Configures the directory or file path of wallpaper
Upload Wallpaper	Allows the user to upload his preferred wallpaper, Must be in JPG or PNG format. 500 KB or smaller in size.
LED Control	
Disable Incoming Call LED Pattern	Disables the LED Pattern that shows when receiving an Incoming Call. Default value is "No"
Disable Missed Call LED Pattern	Disables the LED Pattern that shows when receiving a Missed Call. Default value is "No"
Disable Charging LED Pattern	Disables the LED Pattern that shows when Charging. Default value is "No"
Disable Fully Charged LED Pattern	Disables the LED Pattern that shows when Fully Charged. Default value is "No"
Disable Voicemail LED Pattern	Disables the LED Pattern that shows when there is an unread Voicemail. Default value is "No"
Disable Message LED Pattern	Disables the LED Pattern that shows when there is an unread Message. Default value is "No"
Ringtone	
Call Progress Tones	<p>Configures tone frequencies according to user preference. By default, the tones are set to North American frequencies. Frequencies should be configured with known values to avoid uncomfortable high pitch sounds. ON is the period of ringing ("On time" in "ms" while OFF is the period of silence. Up to three cadences are supported.</p> <ul style="list-style-type: none"> ● Dial Tone ● Second Dial Tone ● Message Waiting ● Ring Back Tone ● Call-Waiting Tone ● Busy Tone

Call Waiting Tone Gain	Configures the call waiting tone gain to adjust call waiting tone volume. Default is “Low”.
Default Ringtone	
Default Ringtone	Configures the default ringtone of the wifi phone
Notification Tone	
Disable WiFi Notification Beep	Disables the WiFi notification beep. Default value is "No"
Disable Charging Beep	Disables the charging beep. Default value is "No"
SIP Message Alert Repeat Count	Controls how many times the alert tone is played when receiving a new message. Default value is 0

Table 27: Settings/Preferences

Settings/Voice Monitoring

Session Report	
VQ RTCP-XR Session Report	When enabled, phone will send a session quality report to the central report collector at the end of each call.
Interval Report	
VQ RTCP-XR Interval Report	When enabled, phone will send an interval quality report to the central report collector periodically throughout a call.
VQ RTCP-XR Interval Report Period	Configure the interval (in seconds) of phone sending an interval quality report to the central report collector periodically throughout a call.
Alert Report	
Warning Threshold for Moslq	Configure the threshold value of listening MOS score (MOS-LQ) multiplied by 10. The threshold value of MOS-LQ causes the phone to send a warning alert quality report to the central report collector.
Critical Threshold for Moslq	Configure the threshold value of listening MOS score (MOS-LQ) multiplied by 10. The threshold value of MOS-LQ causes the phone to send a critical alert quality report to the central report collector.
Warning Threshold for Delay	Configure the threshold value of one way delay (in milliseconds) that causes the phone to send a warning alert quality report to the central report collector.
Critical Threshold for Delay	Configure the threshold value of one way delay (in milliseconds) that causes the phone to send a critical alert quality report to the central report collector.

Table 28: Settings/Voice Monitoring

Network Settings Page Definitions

Network/Basic Settings

Host name (Option 12)	Specifies the name of the client. This field is optional but may be required by Internet Service Providers.
Vendor Class ID (Option 60)	Used by clients and servers to exchange vendor class ID.

Table 29: Network/Basic Settings

Network/Advanced Settings

HTTP Proxy	Specifies the HTTP proxy URL for the phone to send packets to. The proxy server will act as an intermediary to route the packets to the destination.
HTTPS Proxy	Specifies the HTTPS proxy URL for the phone to send packets to. The proxy server will act as an intermediary to route the packets to the destination.
Bypass Proxy For	Enter host names that do not require a proxy to reach. Those names should be separated by commas.
Layer 3 QoS for SIP	Defines the Layer 3 QoS parameter for SIP. This value is used for IP Precedence, Diff-Serv or MPLS. Default is 26.
Layer 3 QoS for RTP	Defines the Layer 3 QoS parameter for RTP. This value is used for IP Precedence, Diff-Serv or MPLS. Default is 46.

Table 30: Network/Advanced Settings

Network/OpenVPN® Settings

OpenVPN® Enable	Enables/Disables OpenVPN® feature. Default is "No".
OpenVPN® mode	Selects OpenVPN® mode: <ul style="list-style-type: none">• Simple Mode: The options below will be visible and the administrator needs to configure them manually.• Expert Mode: Only "Upload OpenVPN® config file" will be available. The administrator can upload the config file. Default is "Simple Mode"
OpenVPN® Server Address	Specify the IP address or FQDN for the OpenVPN® Server.
OpenVPN® Port	Specify the listening port of the OpenVPN® server. The valid range is 1 – 65535. The default value is "1194".
OpenVPN® Transport	Specify the Transport Type of OpenVPN® whether UDP or TCP. The default value is "UDP".
OpenVPN® CA	Click on "Upload" to upload the Certification Authority of OpenVPN®. For a new upload, users could click on "Delete" to erase the last certificate, and then upload a new one.

OpenVPN® Certificate	Click on “Upload” to upload OpenVPN® certificate. For a new upload, users could click on “Delete” to erase the last certificate, and then upload a new one.
OpenVPN® Client Key	Click on “Upload” to upload OpenVPN® Key. For a new upload, users could click on “Delete” to erase the last certificate, and then upload a new one.
OpenVPN® TLS Key	
OpenVPN® Cipher Method	Specifies the Cipher method used by the OpenVPN® server. The available options are: <ul style="list-style-type: none"> ● Blowfish ● AES-128 ● AES-256 ● Triple-DES The default setting is “Blowfish”.
OpenVPN® Username	Configures the optional username for authentication if the OpenVPN server supports it.
OpenVPN® Password	Configures the optional password for authentication if the OpenVPN server supports it.
OpenVPN® Comp-lzo	
Additional Options	Note: Please use this option with caution. Make sure that the options are recognizable by OpenVPN® and do not unnecessarily override the other configurations above. Additional options to be appended to the OpenVPN® config file, separated by semicolons. For example, comp-lzo no;auth SHA256

Network/Wi-Fi Settings

Country	Selects the country code for the Wi-Fi settings.
Advanced Settings	
Power Save Mode	For WP810/822/825 devices, this function enables the user to customize the Power Saving Mode. Four choices are available : <ul style="list-style-type: none"> ● Optimum: This setting will use all available power-saving features available with the current WiFi chipset. ● Relaxed Fast-PS: Return to sleep aggressiveness will be reduced. ● Disable during calling: Power save will be disabled during voice calls to improve compatibility. ● Disable: Radio will run in CAM mode at all times, and battery life will be significantly impacted.
Poor Signal Scan Interval	Sets the time interval for signal scanning when the Wi-Fi signal strength is lower than the signal threshold and there is no hotspot that is higher than the current signal strength. The default value is 5 seconds, Valid Range is from 0 to 300.
Roaming Signal Threshold	Roaming Signal Threshold sets the Wi-Fi signal threshold Wi-Fi. When the Wi-Fi signal strength of the device drops below this configured value, the device will scan for a hotspot above the threshold value and connect to it. The default value is -55, Valid range is -100 to -30
VoWLAN Target Delay	This feature enables the user to configure the jitter buffer target delay. by setting the voice over WLAN Target Delay to either Low, Medium, or high , the default value is Low.

	<p>Note: with firmware release 1.0.11.34, 802.11k and 802.11v standards are supported and they work as follows:</p> <ul style="list-style-type: none"> • 802.11k can help VoWLAN devices make better roaming decisions and minimize the impact of roaming on voice call quality. By providing detailed information about neighboring access points and their capabilities. • 802.11v can be used to optimize QoS for VoWLAN traffic, ensuring that voice traffic is prioritized over other types of traffic in the WLAN. This can help to minimize latency and jitter, which can negatively impact voice quality.
SSID 1-20	
SSID	Wi-Fi name
Enabled	Enable/Disable SSID
Hidden	Specifies if it is a Hidden SSID
Security	
Security Type	<p>This parameter defines the security mode used for the wireless network when the SSID is hidden. 3 Modes are available:</p> <ul style="list-style-type: none"> • WEP • WPA/WPA2 PSK • WPA/WPA2 Enterprise: This feature allows using 802.1x WPA2-Enterprise secure network authentication. • WPA3 PSK. • WPA3 Enterprise.
Password	Password to access Wi-Fi Network
802.11r	This feature allows user to use 802.11r. The default setting is Disabled.
Network	
Internet Protocol	Selects which Internet protocol to use. When both IPv4 and IPv6 are enabled, phone attempts to use preferred protocol first and switches to the other choice if it fails.
IPv4 Address	<p>Select the address mode for the IPv4 Address obtained on the phone. The default is "DHCP". If set to "Static", additional information will be required:</p> <ol style="list-style-type: none"> 1. IPv4 Static Address 2. Subnet Mask 3. Gateway 4. DNS servers 1 & 2
Preferred DNS Server	Enter the Preferred DNS server.
IPv6 Address	<p>Select the address mode for the IPv6 Address obtained on the phone. The default is "Auto-configured". If set to "Statically configured", additional information will be required:</p> <p>Full Static: Configures IPv6 address using Full Static type. Static IPv6 Address IPv6 Prefix length Prefix Static: Configures IPv6 address using Prefix Static type. IPv6 Prefix (64 bits) DNS servers 1 & 2</p>
Preferred DNS Server	Enter the Preferred DNS server.

Maintenance Page Definitions

Maintenance/Web Access

User Password	
New Password	Set new password for web GUI access as User. This field is case sensitive.
Confirm Password	Enter the new User password again to confirm.
Admin Password	
Current Password	The current admin password is required for setting a new admin password.
New Password	Set new password for web GUI access as Admin. This field is case sensitive
Confirm Password	Enter the new Admin password again to confirm.

Table 32: Maintenance/Web Access

Maintenance/Upgrade and Provisioning

Upgrade Firmware	Allows users to upload the firmware file locally by pressing Start, after selecting the correct firmware file from the local storage, the phone will start the firmware upgrade automatically.
Firmware Upgrade and Provisioning	Specifies how firmware upgrading and provisioning request to be sent: Always Check for New Firmware, Check New Firmware only when F/W pre/suffix changes, Always Skip the Firmware Check. The default setting is "Always Check for New Firmware".
Always Authenticate Before Challenge	Only applies to HTTP/HTTPS. If enabled, the phone will send credentials before being challenged by the server. The default setting is "No".
Disable Firmware Upgrade Confirmation	Disables the Firmware Upgrade confirmation popup. Set to "No" by Default.
Validate Hostname in Certificate	To validate the hostname in the SSL certificate
Allow DHCP Option 43 and Option 66 Override Server	Default setting is "Yes". DHCP option 66 originally was only designed for TFTP server. Later on it was extended to support an HTTP URL. WP phones support both TFTP and HTTP server via option 66. Users can also use DHCP option 43 vendor specific option to do this. DHCP option 43 approach has priorities. The phone is allowed to fall back to the original server path configured in case the server from option 66 fails.
Additional Override DHCP Option	When enabled, users could select Option 150 or Option 160 to override the firmware server instead of using the configured firmware server path or the server from option 43 and option 66 in the local network. Please note this option will be effective only when option "Allow DHCP Option 43 and Option 66 to Override Server" is enabled. The default setting is "None".
Allow DHCP Option 120 to override SIP Server	Enables DHCP Option 120 from local server to override the SIP Server on the phone. The default setting is "No".

3CX Auto Provision	Phone will multicast SUBSCRIBE for provision. <i>The default settings is "Yes".</i>
Automatic Upgrade	Enables automatic upgrade and provisioning. <i>The default setting is "No".</i>
Randomized Automatic Upgrade	Randomized Automatic Upgrade within the range of hours of the day or postpone the upgrade every X minute(s) by random 1 to X minute(s).
Hour of the Day (0-23)	Defines the hour of the day to check the HTTP/TFTP/FTP server for firmware upgrades or configuration files changes. The default value is 1.
Day of the Week (0-6)	Defines the day of the week to check HTTP/TFTP/FTP server for firmware upgrades or configuration files changes. The default value is 1.
Disable SIP NOTIFY Authentication	Device will not challenge NOTIFY with 401 when set to "Yes". Default setting is "No".
Config	
Config Upgrade Via	Allows users to choose the config upgrade method: TFTP, FTP, FTPS, HTTP or HTTPS. The default setting is "HTTPS".
Config Server Path	Defines the server path for provisioning.
Config Server Username	The username for the config server.
Config Server Password	The password for the config server.
Config File Prefix	Enables your ITSP to lock configuration updates. If configured, only the configuration file with the matching encrypted prefix will be downloaded and flashed into the phone.
Config File Postfix	Enables your ITSP to lock configuration updates. If configured, only the configuration file with the matching encrypted postfix will be downloaded and flashed into the phone.
XML Config File Password	The password for encrypting XML configuration file using OpenSSL. This is required for the phone to decrypt the encrypted XML configuration file.
Authenticate Conf File	Sets the phone system to authenticate configuration file before applying it. When set to "Yes", the configuration file must include value P1 with phone system's administration password. If it is missed or does not match the password, the phone system will not apply it. Default setting is "No".
Download Device Configuration	Click to download phone's configuration file in .txt format. Note: Configuration backup file does not include passwords or CA/Custom certificate
Download Device Configuration (XML)	Click to download the device configuration file in .xml format.

Download and Process All Available Config Files	<p>By default, device will provision the first available config in the order of cfgMAC, cfgMAC.xml, cfgMODEL.xml and cfg.xml (corresponding to device specific, model specific and global configs).</p> <p>If this option is enabled, the phone will inverse the downloading process to cfg.xml > cfgMAC.bin > cfgMAC.xml.</p> <p>The following files will override the files that has already been load and processed.</p>
Download User configuration	This allows users to download part of the configuration that does not include any personal settings like Username and Passwords. Also, it will include all the changes manually made by user from web UI, or config file uploaded from "Upload Device Configuration", but not include the changes from the server provision via TFTP/FTP/FTPS/HTTP/HTTPS.
Upload Device Configuration	Uploads configuration file to phone.
Export backup Package	Export backup package which contains device configuration along with personal data.
Restore from Backup package	Click to upload backup package and restore.
Firmware	
Firmware Upgrade Via	Allows users to choose the firmware upgrade method: TFTP, FTP, FTPS, HTTP or HTTPS. The default setting is "HTTPS".
Firmware Server Path	Defines the server path for the firmware server.
Firmware Server Username	The username for the firmware server.
Firmware Server Password	The password for the firmware server.
Firmware File Prefix	Enables your ITSP to lock firmware updates. If configured, only the firmware with the matching encrypted prefix will be downloaded and flashed into the phone.
Firmware File Postfix	Enables your ITSP to lock firmware updates. If configured, only the firmware with the matching encrypted postfix will be downloaded and flashed into the phone.

Table 33: Maintenance/Upgrade and Provisioning

Maintenance/Syslog

Syslog Protocol	<p>If set to SSL/TLS, the syslog messages will be sent through secured TLS protocol to syslog server.</p> <p>Default setting is UDP.</p> <p>Note: The CA certificate is required to connect with the TLS server.</p>
Syslog Server	<p>The URL or IP address of the syslog server for the phone to send syslog to.</p> <p>Note: By adding port number to the Syslog server field (i.e. 172.18.1.1:1000), the phone will send syslog to the corresponding port of that IP.</p>

Syslog Level	<p>Selects the level of logging for syslog.</p> <p>The default setting is "None". There are 4 levels: DEBUG, INFO, WARNING and ERROR.</p> <p>Syslog messages are sent based on the following events:</p> <ul style="list-style-type: none"> ○ Product model/version on boot up (INFO level). ○ NAT related info (INFO level). ○ sent or received SIP message (DEBUG level). ○ SIP message summary (INFO level). ○ inbound and outbound calls (INFO level). ○ registration status change (INFO level). ○ negotiated codec (INFO level). ○ Ethernet link up (INFO level). ○ SLIC chip exception (WARNING and ERROR levels). ○ Memory exception (ERROR level).
Syslog Keyword Filtering	<p>Syslog will be filtered based on keywords provided. If you enter multiple keywords, it should be separated by ';'. Please note that no spaces are allowed.</p>
Send SIP Log	<p>Configures whether the SIP log will be included in the syslog messages. The default setting is "No".</p> <p>Note: By setting Send SIP Log to Yes, the phone will still send SIP log from syslog even when Syslog Level set to NONE.</p>
Capture	
Status	<p>Shows the status of the capture.</p>
Capture Location	<p>Defines the location where the capture will be stored. Available choices for location are Internal Storage or USB.</p> <p>Default setting is Internal Storage.</p>
Capture Mode	<p>Sets the capture mode. Either set to Timed mode or continuous.</p> <ul style="list-style-type: none"> • Timed Mode: When a new capture is running, the previous files are deleted. Capture Timer is optional, if Internal Storage is selected, the maximum Capture Timer limit is 30 minutes. • Continuous Mode: This mode allows device to capture logs continuously during the days set under Continuous Capture Days option.
Capture Timer	<p>If Capture Mode is set to "Timed" this field will appear to specify how long to capture syslog in minutes. 0 is unlimited. Internal capture has a 30-minute maximum limit.</p>
Log File Rotation	<p>Rotation is always enabled when capturing internally.</p> <p>Log File Rotation will maintain a fixed maximum limit of the file size based on the Max Log File Size and Max Log Files configured. Old logs will be deleted when rotated.</p>
Max Log File Size	<p>The maximum log file size used when rotation is enabled</p>
Max Log Files	<p>The number of log files used when rotation is enabled</p>

Maintenance/TR-069

Enable TR-069	<p>Sets the phone to enable the “CPE WAN Management Protocol” (TR-069). The default setting is “Yes”.</p> <p>Note: Once you enable or disable TR-069 and click “save,” a confirmation pop-up will appear, asking you to confirm your desire to reboot the device.</p>
ACS URL	<p>Specifies URL of TR-069 ACS (e.g., http://acs.mycompany.com), or IP address.</p> <p>The default setting is https://acs.dgms.cloud</p>
TR-069 Username	<p>Specifies the username to authenticate to ACS.</p>
TR-069 Password	<p>Specifies the password to authenticate to ACS.</p>
Periodic Inform Enable	<p>When enabled, periodic inform packets to ACS server will be sent.</p> <p>The default setting is “Yes”</p>
Periodic Inform Interval	<p>Configures periodic inform interval to send the inform packets to TR-069 Auto Configuration Server.</p> <p>The default setting is 86400</p>
Connection Request Username	<p>Specifies the username for the ACS to connect to the phone.</p>
Connection Request Password	<p>Specifies the password for the ACS to connect to the phone.</p>
Connection Request Port	<p>The port for the ACS to connect to the phone.</p>
CPE SSL Certificate	<p>Uploads Cert File for the phone to connect to the ACS via SSL.</p>
CPE SSL Private Key	<p>Uploads Cert Key for the phone to connect to the ACS via SSL.</p>
Randomized TR069 Startup	<p>When enabled, TR069 will send out first INFORM message to server on randomized timing between 1 to 3600 seconds after phone boots up.</p>

Table 35: Maintenance/TR-069

Maintenance/Security Settings

Security	
Configuration via Keypad Menu	<p>Configures the access control for the users to configure from the keypad Menu. There are four different options:</p> <ul style="list-style-type: none"> • Unrestricted: All the options can be accessed in the keypad Menu. • Basic settings only: Account settings, Network, and Advanced Settings are hidden from the keypad menu. • Basic settings & Network settings: Only basic settings, call features, and network settings can be available in LCD Menu. • Constraint Mode: The phone will require an administrator password to change Wireless & network and Advanced Settings and to access the Call Settings menu along with the DND toggle function.

	<ul style="list-style-type: none"> • Locked Mode: The phone menu is disabled. <p>The default setting is “Unrestricted”.</p>
Factory Reset Security Level	<p>Allows Factory Reset under certain security constraints.the options available are</p> <ul style="list-style-type: none"> • Default • Always Require Passsword • No Password required <p>The default value is "Default" which will not require any password upon factory reset.</p>
Validate Server Certificates	<p>After enabling this feature, the phone will validate the server’s certificate. If the server that our phone tries to register on is not on our list, it will not allow the server to access the phone.</p> <p>Note: New Digicert certificates have been integrated and supported since firmware 1.0.11.28</p>
SIP TLS Certificate	SSL Certificate used for SIP Transport in TLS/TCP.
SIP TLS Private Key	SSL Private key used for SIP Transport in TLS/TCP.
SIP TLS Private Key Password	SSL Private key password used for SIP Transport in TLS/TCP.
Custom Certificate	The uploaded custom certificate will be used for SSL/TLS communication instead of the WP phone default certificate.
Web Access Mode	Sets the protocol for web interface. The default setting is “HTTP”.
Enable User Web Access	Administrator can disable or enable user web access. Default is Enabled.
HTTP Web Port	Configures the HTTP port under the HTTP web access mode.
HTTPS Web Port	Configures the HTTPS port under the HTTPS web access mode. Default setting is “443”.
Disable SSH	Disables SSH access. The default setting is “No”.
SSH Public Key	<p>This option allows you to use authentication keys for SSH access. The public key should be loaded to the phone’s web UI while the private key should be used on the SSH tool side.</p> <p>Note: This will allow upcoming SSH access without a password.</p>
Web Session Timeout	Configures timer to logout web session during idle. Default is 10 min. Range is 2-60 min.
Web Access Attempt Limit	Configures attempt limit before lockout. Default is 5. Range is 1-10.
Minimum TLS Version	<p>Allows users to choose the minimum TLS version for HTTPS provisioning.</p> <p>Note: Minimum TLS version should be less or equal to the Maximum TLS version. The default setting is TLS 1.1</p>
Maximum TLS Version	Allows users to choose the maximum TLS version for HTTPS provisioning.
Trusted CA Certificates	
Trusted CA	Allows to upload and delete the CA Certificate file to phone.

Certificates	Note: Users can either upload the file directly from web or they can choose to provision it from their cfg.xml file.
Load CA Certificates	<p>Users are able to specify which certificate they are going to use:</p> <ul style="list-style-type: none"> • All Certificates: (Default) Both built-in and uploaded Certificates. • Default Certificates: Built-in Certificates. • Custom Certificates: Uploaded Certificates;

Maintenance/Package Capture

Field	Description
Capture Location	Location where the capture will be stored. Internal storage or USB.
With RTP Packets	Choose whether the packet capture file contains RTP or not.
With Secret Key Information	Include secret key to decrypt the capture TLS packets
USB Filename	Filename of the capture. Only required for USB.
Capture in Monitor Mode	Select "Yes" from the drop-down list to make packet capture based on a specific Channel and Bandwidth.
Monitor Mode Channel	Select the Channel from the drop-down list to be monitored for Packet Capture. <i>Note: Channel support is restricted by the device region.</i>
Monitor Mode Bandwidth	Select the Channel Bandwidth to be monitored for Packet Capture. <i>Note: Channels 1-13 and 165 are restricted to 20 MHz.</i>

Table 37: Maintenance/Package Capture

Maintenance/Tools

Provision	Makes the phone trigger an instant provisioning.
Factory Reset	Sets back the phone to the factory default settings.
Ping	Makes the phone ping an URL to check if it has access to it.
Traceroute	Checks the route packets take to the specified URL.

Table 38: Maintenance/Tools

Directory Page Definitions

Directory/Contacts

Search Bar	Allows users searching for phonebook entries.
-------------------	-----------------------------------------------

Add Contact	Specifies Contact's First Name, Last Name, Phone Number, Accounts and Groups (Blacklist, Whitelist, Work, Friends and Family) to add one new contact in phonebook. Note: If the contact number belongs to Blacklist group, the call from this number will be blocked. If the contact number belongs to Whitelist group, when the phone is on DND mode, the call from whitelist number will be allowed.
Edit Contact	Edits selected contact.
Delete All Contacts	Deletes all contacts from phonebook. NOTE: a message prompt will be displayed so that users will confirm to delete or cancel the operation, in order to prevent users from losing contacts when deleting them accidentally.

Table 39: Directory/Contacts

Directory/Phonebook Management

Enable Phonebook XML Download	Enables Phonebook XML download via HTTP, HTTPS, or TFTP.
HTTP/HTTPS User Name	The user name for the HTTP/HTTPS server.
HTTP/HTTPS Password	The password for the HTTP/HTTPS server
Phonebook XML Server Path	Configures the server path to download XML phonebook file. This field could be IP address or URL, with up to 256 characters.
Phonebook Download Interval	Configures the phonebook download interval (in minutes). If set to 0, automatic download will be disabled. Valid range is 5 to 720.
Remove Manually-edited Entries on Download	If set to "Yes", when XML phonebook is downloaded, the entries added manually will be automatically removed.
Download XML Phonebook	Click on "Download" to download the XML phonebook file to local PC
Upload XML Phonebook	Click on "Upload" to upload local XML phonebook file to the phone.

Table 40: Directory/Phonebook Management

Directory/Call History

Call History	
Delete	Users can select an entry, then click "Delete" to remove it from the list.
Delete all	Click on Delete All in order to remove all Call History stored in the phone. Note: Users could use the drop-down list to show only selected call history type (All, Answered, Dialed, Missed, Transferred) and also use navigation keys to browse pages when many entries exist.

Table 41: Directory/Call History

Directory/LDAP

LDAP protocol	Select protocol options: LDAP or LDAPS.
Server Address	Configures the IP address or DNS name of the LDAP server.
Port	Configures the IP address or DNS name of the LDAP server. Default is 389.
Base	This is the location in the directory where the search is requested to begin. Example: dc=grandstream, dc=com ou=Boston, dc=grandstream, dc=com
User Name	Configures the bind "Username" for querying LDAP servers. The field can be left blank if the LDAP server allows anonymous binds.
Password	Configures the bind "Password" for querying LDAP servers. The field can be left blank if the LDAP server allows anonymous binds.
LDAP Number Filter	Configures the filter used for number lookups.
LDAP Name Attributes	Specifies the "number" attributes of each record which are returned in the LDAP search result. Example: telephoneNumber telephoneNumber Mobile
LDAP Number Attributes	Specifies the "number" attributes of each record which are returned in the LDAP search result. Example: telephoneNumber telephoneNumber Mobile
LDAP Display Name	Configures the entry information to be shown on phone's LCD. Up to 3 fields can be displayed. Example: %cn %sn %telephoneNumber
Max. Hits	Specifies the maximum number of results to be returned by the LDAP server. Valid range is 1 to 3000. Default is 50.
Search Timeout	Specifies the interval (in seconds) for the server to process the request and client waits for server to return. Valid range is 0 to 180. Default is 30.
LDAP Lookup	Configures to enable LDAP number searching when dialing and receiving calls.

Table 42: Directory/LDAP

UPGRADING AND PROVISIONING

The WP810/WP822/WP825 can be upgraded via TFTP/HTTP/HTTPS by configuring the URL/IP Address for the TFTP/HTTP/HTTPS server and selecting a download method. Configure a valid URL for TFTP, HTTP or HTTPS; the server name can be FQDN or IP address.

Upgrade and Provisioning Configuration

There are two ways to setup upgrade and provisioning on WP810/WP822/WP825. They are Keypad Menu and Web GUI.

Configure via keypad Menu

1. In WP810/WP822/WP825 Settings, select **Advanced Settings** → **System Upgrade**.
2. Navigate to **Firmware** and configure the firmware upgrade server path.

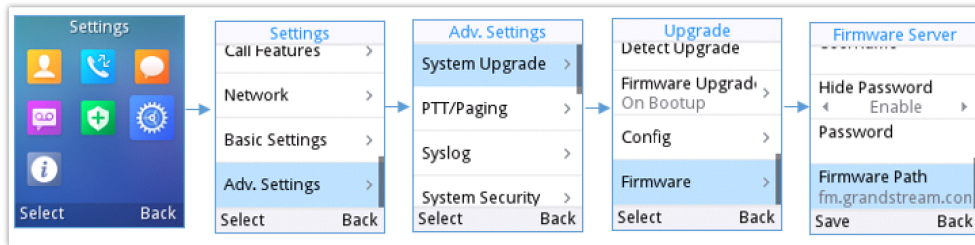

Figure 17: Upgrade Configuration via Keypad Menu

Configure via Web GUI

Open a web browser on PC and enter the IP address for the WP810/WP822/WP825. Then login with the administrator username and password. Go to **Maintenance** → **Upgrade and Provisioning** → **Firmware**, enter the IP address or the FQDN for the upgrade server and choose to upgrade via TFTP, HTTP or HTTPS (The default setting is HTTPS). Save and apply the changes or reboot the phone for the upgrade process to begin.

Note

After applying settings, A reboot confirmation pop up will be displayed for certain configurations

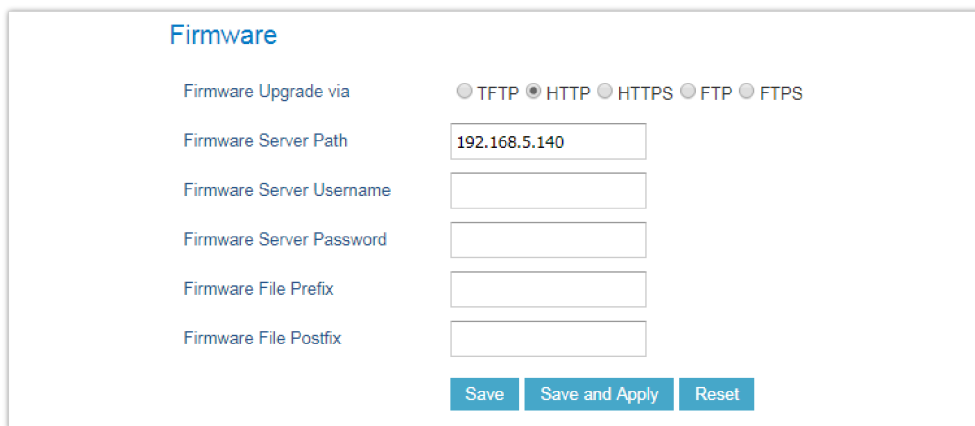

Figure 18: Upgrade Configuration via Web GUI

Warning

- Please do not power off or unplug the device when the upgrading process is on.
- In case wrong firmware file is uploaded or something goes wrong, an error message will be prompt indicating that the firmware upgrade failed.

Local Firmware Servers

Instructions for local firmware upgrade via TFTP:

1. Unzip the firmware files and put all of them in the root directory of the TFTP server.
2. Connect the PC running the TFTP server and the WP810/WP822/WP825 device to the same LAN segment.

3. Start the TFTP server and configure the TFTP server in the phone's web configuration interface.
4. Configure the Firmware Server Path on your WP810/WP822/WP825 to the IP address of the PC.
5. Update the changes and reboot the WP810/WP822/WP825.

Provisioning and Configuration File Download

Grandstream SIP Devices can be configured via the Web Interface as well as via a Configuration File (binary or XML) through TFTP or HTTP/HTTPS. The "Config Server Path" is the TFTP, HTTP or HTTPS server path for the configuration file. It needs to be set to a valid URL, either in FQDN or IP address format. The "Config Server Path" can be the same or different from the "Firmware Server Path".

A configuration parameter is associated with each field in the web configuration page. A parameter consists of a Capital letter P and 1 to 5 (could be extended to more in the future) digit numeric numbers. i.e. For a detailed parameter list, please refer to the corresponding firmware release configuration template in the following link: <https://www.grandstream.com/support/tools>

When the WP810/WP822/WP825 boots up, it will issue TFTP or HTTP(S) request to download a configuration XML file named "cfgxxxxxxxxx" followed by "cfgxxxxxxxxx.xml", where "xxxxxxxxxx" is the MAC address of the phone, i.e., "cfg000b820102ab" and "cfg000b820102ab.xml". If downloading "cfgxxxxxxxxx.xml" file is not successful, the provision program will download a generic cfg.xml file. The configuration file name should be in lower case letters.

For more details on XML provisioning, please refer to the following document:

<https://documentation.grandstream.com/knowledge-base/sip-device-provisioning-guide/>

FACTORY RESET

Restore to Factory Default via LCD Menu

Warning

Restoring the Factory Default Settings will delete all configuration information on the phone. Please backup or print all the settings before you restore to the factory default settings. Grandstream is not responsible for restoring lost parameters and cannot connect your device to your VoIP service provider.

There are two methods to restore the WP810/WP822/WP825 to the factory default settings.

1. On WP810/WP822/WP825 idle screen, go to **Settings** → **Advanced Settings** → **Factory reset**.
2. In the new window, confirm the reset using the left softkey.

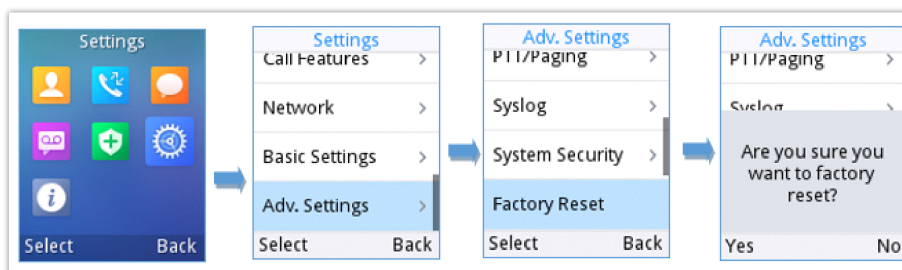

Figure 19: LCD – Confirm Factory Reset

3. Once confirming the factory reset, the phone will reboot with the default factory settings.

Restore to Factory Default via the Web GUI

1. Login WP810/WP822/WP825 Web GUI and go to **Maintenance** → **Tools**.
2. Click on the **Start** button in front of **Factory Reset**.



Figure 20: Web GUI – Factory Reset

3. A dialog box will pop up to confirm factory reset.
4. Click OK to restore the phone to factory settings.

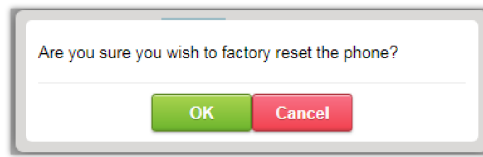

Figure 21: Web GUI – Confirm Factory Reset

CHANGE LOG

This section documents significant changes from previous firmware versions. Only major new features or major document updates are listed here. Minor updates for corrections or editing are not documented here.

Firmware Version 1.0.11.40

- Added "Enable Live DialPad" and "Live DialPad Expire Time". [[Live DialPad](#)]
- Added the prompt information while enable or disable the TR-069 function requires a restart to take effect. [[Enable TR-069](#)]

Firmware Version 1.0.11.34

- Added support for increased jitter buffer target delay. [[VoWLAN Target Delay](#)]
- Added support for 802.11k and 802.11v standards. [[VoWLAN Target Delay](#)]
- Added roam scan parameters. [[Poor Signal Scan Interval and Roaming Signal Threshold](#)]
- Added support for power saving. [[Power save mode](#)]
- Enhanced "Network Monitor" which supports MAC address on LCD. [[Network status](#)]
- Added support for disabling the DND mode. [[Enable DND Feature](#)]
- Added support for contact name format. [[Contact name format](#)]
- Added support for lock volume control. [[Lock Speaker Volume](#)]
- Added support set the volume from WebUI. [[Speaker Ring Volume](#)]
- Added support for Headset TX Gain. [[Headset TX Gain](#)]
- Added support for Headset RX Gain. [[Headset RX Gain](#)]
- Added support for Handset TX Gain. [[Handset TX Gain](#)]

Firmware Version 1.0.11.28

- Added support for reboot notification for certain if must reboot to apply settings. [[Reboot Confirmation](#)]
- Added support for different account ringtones without using Match Incoming Caller ID. [[Account Ringtone and Default Ringtone](#)]
- Added Support to configure F-timer and B-timer. [[SIP Timer B Timeout](#)] [[SIP Timer F Timeout](#)]
- Integrate new Digicert certificates in firmware. [[Validate Server Certificates](#)]
- Added the options to control the indicated LED pattern. [[LED Control](#)]
- Added support for factory resetting the security level. [[Factory Reset Security Level](#)]
- Added support for upgrade prompt bypass. [[Disable Firmware Upgrade Confirmation](#)]
- Added support to disable the Notification Tone. [[Notification Tone](#)]
- Added support for SIP messages tone. [[SIP Message Alert Repeat Count](#)]
- Added support for the Maximum Number of SIP Request Retries. [[Maximum Number of SIP Request Retries](#)]
- Added support for Failback Timer. [[Failback Timer](#)]

- Added the option "Saved one until failback timer expires" in DNS SRV Fail-over Mode. [[Saved one until failback timer expires](#)]

Firmware Version 1.0.11.22

- Added new feature to disable redial with # key. [[Account/Call Settings](#)]
- Added new feature to support for OpenVPN®. [[Network/OpenVPN®](#)]

Firmware Version 1.0.11.20

- Added new feature to support capture SSL Key Log File [[With System Key Information](#)]
- Added new features in Packet Capture monitor mode support. [[Capture in Monitor Mode](#)]
- Added 3CX Auto Provision option. [[3CX Auto Provision](#)]
- Added support to connect up to 20 SSIDs.
- Added door system support and GDS settings [[Grandstream Door System](#)]
- Added support for Off-hook Auto Dial. [[Off-hook Auto Dial](#)]
- Added support for Audio Control. [[Audio Control](#)]

Firmware Version 1.0.11.8

- Added new option "Enable TCP Keep Alive". [[Enable TCP Keep Alive](#)]
- Added new option to enable/disable "Off-cradle Pickup". [[Off-cradle Pickup](#)]
- Added new option to enable/disable call end tone. [[Disable Call End Tone](#)]

Firmware Version 1.0.11.2

- Added support for disable in-call DTMF display. [[Settings/Call Features](#)]

Firmware Version 1.0.9.23

- Added support for WPA3 Wi-Fi security. [[Network/Wi-Fi Settings](#)]
- Added support for LDAP configuration. [[Directory/LDAP](#)]
- Added support for Allow Dial Through Popups. [[Settings/General Settings](#)]
- Added option "Use MAC Header" for account 1 and account 2. [[Account/SIP Settings](#)]
- Updated option "Use MAC Header" to "Add MAC in User-Agent" for account 1 and account 2. [[Account/SIP Settings](#)]
- Added support busy tone configuration to the web GUI. [[Settings/Preferences](#)]

Firmware Version 1.0.7.83

- No major changes.

Firmware Version 1.0.7.68

- Added support for GDMS. [[TR-069](#)]
- Added support for Turkish language. [[Multi-language](#)]
- Added Japanese language support on LCD. [[Multi-language](#)]
- Update Wi-Fi Security type from "WPA PSK" to "WPA/WPA2 PSK". [[Security Type](#)]
- Added support for "Feature Key Synchronization". [[Feature Key Synchronization](#)]
- Added support for "Capture". [[Capture](#)]
- Added support for "Matching Incoming Caller ID". [[Match Incoming Caller ID](#)]
- Added support for TR-069 configuration. [[TR-069](#)]
- Added support for "Configuration via Keypad Menu". [[Configuration via Keypad Menu](#)]
- Added support for "Register Before DNS SRV Failover". [[Register Before DNS SRV Failover](#)]
- Added support for Minimum and Maximum TLS Version configuration. [[Minimum TLS Version](#)] [[Maximum TLS Version](#)]

- Added support for 802.11r. [[802.11r](#)]
- Added support to configure Country Code while configuring Wi-Fi from handset on the first time. [[Country](#)]
- Added support to differentiate rejected calls icon from missed calls. Now the rejected calls will be logged as received calls with different icon. [[Icons Description](#)]

Firmware Version 1.0.7.18

- Added support to download a phonebook from the server [[Directory/Phonebook Management](#)].
- Added support for "Disable Recovery on Blind Transfer" [[Disable Recovery on Blind Transfer](#)].

Firmware Version 1.0.7.7

- Added Multicast Listening setting fields for Multicast Paging settings on web UI [[Multicast Listening](#)].

Firmware Version 1.0.1.1

- This is the initial version.

© 2002-2014 OpenVPN Technologies, Inc. OpenVPN is a registered trademark of OpenVPN Technologies, Inc.

Need Support?

Can't find the answer you're looking for? Don't worry we're here to help!

[CONTACT SUPPORT](#)