



Cisco Unified IP Phone 8961, 9951, and 9971 User Guide for Cisco Unified Communications Manager 10.0 (SIP)

First Published: 2013-11-05

Last Modified: 2018-04-30

Americas Headquarters

Cisco Systems, Inc.
170 West Tasman Drive
San Jose, CA 95134-1706
USA
<http://www.cisco.com>
Tel: 408 526-4000
800 553-NETS (6387)
Fax: 408 527-0883

THE SPECIFICATIONS AND INFORMATION REGARDING THE PRODUCTS IN THIS MANUAL ARE SUBJECT TO CHANGE WITHOUT NOTICE. ALL STATEMENTS, INFORMATION, AND RECOMMENDATIONS IN THIS MANUAL ARE BELIEVED TO BE ACCURATE BUT ARE PRESENTED WITHOUT WARRANTY OF ANY KIND, EXPRESS OR IMPLIED. USERS MUST TAKE FULL RESPONSIBILITY FOR THEIR APPLICATION OF ANY PRODUCTS.

THE SOFTWARE LICENSE AND LIMITED WARRANTY FOR THE ACCOMPANYING PRODUCT ARE SET FORTH IN THE INFORMATION PACKET THAT SHIPPED WITH THE PRODUCT AND ARE INCORPORATED HEREIN BY THIS REFERENCE. IF YOU ARE UNABLE TO LOCATE THE SOFTWARE LICENSE OR LIMITED WARRANTY, CONTACT YOUR CISCO REPRESENTATIVE FOR A COPY.

The following information is for FCC compliance of Class A devices: This equipment has been tested and found to comply with the limits for a Class A digital device, pursuant to part 15 of the FCC rules. These limits are designed to provide reasonable protection against harmful interference when the equipment is operated in a commercial environment. This equipment generates, uses, and can radiate radio-frequency energy and, if not installed and used in accordance with the instruction manual, may cause harmful interference to radio communications. Operation of this equipment in a residential area is likely to cause harmful interference, in which case users will be required to correct the interference at their own expense.

The following information is for FCC compliance of Class B devices: This equipment has been tested and found to comply with the limits for a Class B digital device, pursuant to part 15 of the FCC rules. These limits are designed to provide reasonable protection against harmful interference in a residential installation. This equipment generates, uses and can radiate radio frequency energy and, if not installed and used in accordance with the instructions, may cause harmful interference to radio communications. However, there is no guarantee that interference will not occur in a particular installation. If the equipment causes interference to radio or television reception, which can be determined by turning the equipment off and on, users are encouraged to try to correct the interference by using one or more of the following measures:

- Reorient or relocate the receiving antenna.
- Increase the separation between the equipment and receiver.
- Connect the equipment into an outlet on a circuit different from that to which the receiver is connected.
- Consult the dealer or an experienced radio/TV technician for help.

Modifications to this product not authorized by Cisco could void the FCC approval and negate your authority to operate the product

The Cisco implementation of TCP header compression is an adaptation of a program developed by the University of California, Berkeley (UCB) as part of UCB's public domain version of the UNIX operating system. All rights reserved. Copyright © 1981, Regents of the University of California.

NOTWITHSTANDING ANY OTHER WARRANTY HEREIN, ALL DOCUMENT FILES AND SOFTWARE OF THESE SUPPLIERS ARE PROVIDED "AS IS" WITH ALL FAULTS. CISCO AND THE ABOVE-NAMED SUPPLIERS DISCLAIM ALL WARRANTIES, EXPRESSED OR IMPLIED, INCLUDING, WITHOUT LIMITATION, THOSE OF MERCHANTABILITY, FITNESS FOR A PARTICULAR PURPOSE AND NON-INFRINGEMENT OR ARISING FROM A COURSE OF DEALING, USAGE, OR TRADE PRACTICE.

IN NO EVENT SHALL CISCO OR ITS SUPPLIERS BE LIABLE FOR ANY INDIRECT, SPECIAL, CONSEQUENTIAL, OR INCIDENTAL DAMAGES, INCLUDING, WITHOUT LIMITATION, LOST PROFITS OR LOSS OR DAMAGE TO DATA ARISING OUT OF THE USE OR INABILITY TO USE THIS MANUAL, EVEN IF CISCO OR ITS SUPPLIERS HAVE BEEN ADVISED OF THE POSSIBILITY OF SUCH DAMAGES.

Any Internet Protocol (IP) addresses and phone numbers used in this document are not intended to be actual addresses and phone numbers. Any examples, command display output, network topology diagrams, and other figures included in the document are shown for illustrative purposes only. Any use of actual IP addresses or phone numbers in illustrative content is unintentional and coincidental.

Cisco and the Cisco logo are trademarks or registered trademarks of Cisco and/or its affiliates in the U.S. and other countries. To view a list of Cisco trademarks, go to this URL: <https://www.cisco.com/go/trademarks>. Third-party trademarks mentioned are the property of their respective owners. The use of the word partner does not imply a partnership relationship between Cisco and any other company. (1721R)

© 2013-2018 Cisco Systems, Inc. All rights reserved.



CONTENTS

CHAPTER 1

Getting Started 1

- Accessibility Features 1
- Cisco Unified IP Phone 8961 1
 - Phone Connections for Cisco Unified IP Phone 8961 1
 - Buttons and Hardware 3
 - Phone with Single Line 7
 - Phone with Multiple Lines 9
- Cisco Unified IP Phone 9951 10
 - Phone Connections for Cisco Unified IP Phone 9951 10
 - Bluetooth 12
 - Buttons and Hardware 12
 - Phone with Single Line 16
 - Phone with Multiple Lines 17
- Cisco Unified IP Phone 9971 19
 - Phone Connections for Cisco Unified IP Phone 9971 19
 - Wireless Connection and Bluetooth 21
 - Buttons and Hardware 21
 - Phone with Single Line 25
 - Phone with Multiple Lines 26
- Power Save and Power Save Plus 28
 - Power Save 28
 - Power Save Plus 28
- Additional Information 29

CHAPTER 2

Phone Setup 31

- Connect Footstand 31
- Adjust Phone Display Viewing Angle 32
- Adjust the Handset Rest 33

Secure the Phone with a Cable Lock 34

CHAPTER 3**Basic Operations 35**

Clean the Phone Screen 35

Clean the Phone Touchscreen Display 36

Make Calls 36

 Make a Call with the Speakerphone 37

 Place Call Using Headset 37

 Release Call and Start Another Call 37

 Dial Number On-Hook 37

 Dial an International Number 38

 Redial a Number 38

 Make Priority Call with Login to SIP 39

 Make Priority Call Without Login to SIP 39

Navigate and Select Items 40

View All Calls on Phone 40

Answer Calls 41

 Answer the Oldest Call First 41

 Call Pickup 41

 Answer a Call Within Your Group (Pickup) 42

 Answer a Call Using Group Pickup and a Phone Number 42

 Answer a Call Using Group Pickup and a Group Pickup Number 43

 Answer a Call From an Associated Group (Other Pickup) 43

Answer Calls Automatically 43

Answer Call Waiting 44

Manage Calls 44

 Divert a Call 44

 Transfer Call to Another Number 45

 Consult Before You Complete a Transfer 45

 Record a Call 46

Call Forward 46

 Forward Calls 46

Mute Phone 46

Hold Call 47

 Swap Between Active and Held Calls 47

Put Call on Hold by Answering New Call	48
Answer a Call Left on Hold for Too Long	48
Determine If a Shared Line Is On Hold	48
Remote Hold	48
Get Notified When a Contact is Available	48
Call Park	49
Park and Retrieve a Call Using Call Park	49
Place a Call on Hold with Assisted Directed Call Park	50
Place a Call on Hold with Manual Directed Call Park	50
Intercom Calls	51
Place a Dedicated Intercom Call	51
Place a Dialable Intercom Call	51
Answer an Intercom Call	52
Video Calls	52
Toggle Between Phone and Video Display	52
Hide Softkeys in Full-Screen Video	53
Enable Full Screen Video	53
Mute Video	53
Swap Views	54
Adjust the Picture-In-Picture Position	54
View Phone Information	54
Sign In to the Cisco Unified Communications Self Care Portal	55

CHAPTER 4**Contacts 57**

Corporate Directory	57
Search and Dial Contact	57
Search and Dial Contact While on Call	58
Personal Directory	58
Sign In and Out of a Personal Directory	58
Add Personal Directory Entry from Phone	59
Search for a Contact in Your Personal Directory	59
Dial a Number from Your Personal Directory	60
Edit Personal Directory Entry	60
Delete Personal Directory Entry	61
Fast Dial	61

- Place Call with Fast Dial Button 61
- Fast-Dial Codes with Personal Directory 61
 - Assign Fast-Dial Code to Personal Directory Entry 62
 - Call a Contact with a Fast-Dial Code 62
 - Delete a Fast-Dial Code 62
- Cisco Web Dialer 63
 - Use Cisco Web Dialer with Another Online Corporate Directory 63
 - Change Cisco Web Dialer Preferences 63
 - Sign Out of Cisco Web Dialer 64

CHAPTER 5

- Call History 65**
 - Call History Overview 65
 - View Call History 67
 - View Call Record Details 67
 - Filter Call History 68
 - Dial from Call History 68
 - Edit Number from Call History 69
 - Clear Call History 69
 - Delete Call Record from Call History 69

CHAPTER 6

- Voicemail 71**
 - Your Voicemail Account 71
 - Access Voicemail 71
 - Check for Voice Messages 72
 - Listen to Voice Messages 72

CHAPTER 7

- Advanced Calling Features 75**
 - Conference Calls and Meetings 75
 - Add Third Party to Conference 76
 - Join Calls into Conference 76
 - Swap Between Calls Before You Complete a Conference 76
 - View and Remove Conference Participants 77
 - Remove Conference Participants 77
 - Scheduled Conference Calls (Meet Me) 77
 - Host a Meet-Me Conference 77

Join a Meet-Me Conference	78
Speed Dial	78
Make a Call with a Speed-Dial Button	78
Use Speed-Dial Code On-Hook	79
Use Speed-Dial Code Off-Hook	79
Pauses in Speed Dial	79
Do Not Disturb	80
Turn On Do Not Disturb	81
Malicious Call Identification	81
Trace a Suspicious Call	81
Extension Mobility	81
Sign In to Your Extension from Another Phone	81
Phone Calls with Mobile Connect	82
Enable Mobile Connect	82
Turn On Mobile Connect from a Desk Phone	83
Move a Call from Your Desk Phone to Your Mobile Phone	83
Move a Call from Your Mobile Phone to Your Desk Phone	83
Transfer a Call from Your Mobile Phone to Your Desk Phone	84
Line Status	84
Line Status Indicators	84
Custom Line Filters	85
Add a Line Filter	86
Select an Active Line Filter	86
Delete a Line Filter	87
Duplicate a Line Filter	87
Edit a Line Filter	87
Rename a Line Filter	88
Hunt Groups	88
Sign In and Out of a Hunt Group	88
View the Call Queue in a Hunt Group	88
Barge	89
Set up Barge Alert	89
Add Yourself to a Call on a Shared Line	89
Enable Privacy on a Shared Line	90
Toggle Prompt for Barge	90

Dismiss Barge Alert Prompt Window	90
Call Chaperone	91
Record Chaperoned Call	91
Uniform Resource Identifier Dialing	92

CHAPTER 8

Advanced Operations	95
Applications	95
View Active Applications	95
Switch to Active Application	96
Close Active Application	96
Video Calls and Security	96
Call Functions	96
Agent Greeting	96
Alert Calls	97
Actionable Incoming Call Alert	97
Answer	97
Client Matter Code	98
Forced Authorization Code	98
Secure Calls	98
Shared Lines	98
Feature Buttons and Softkeys	99
Survivable Remote Site Telephony Overview	100
WLAN Sign-In	103
Sign In to WLAN	103
Change WLAN Sign-In	104
VPN client	104
VPN Connection Settings	105
Connect Through VPN	105
Change Your VPN to Another Network	106
Cisco VXC VPN	106
Plugins	107
Cisco IP Manager Assistant	107
Manager Phones	107
Manager Settings Menu	109
Select Assistant	109

- Subscribe to Assistant Primary Phone Service 109
- Assistant Phones 110
 - Assistant Console 110
 - Assistant Settings Menu 110
 - Set Divert Target 111
 - Enable CallPlane Overwrite 112
 - Enable Smart Sorting 112
 - Assistant Manager Status Menu 112
 - Manager Settings Menu on Assistant Phone 113
 - Log In to IPMA Service on Phone 114

CHAPTER 9**User Preferences 115**

- Adjust Phone Screen Brightness 115
- Adjust Headset Sidetone 116
- Change Ringtone 116
- Change Wallpaper 117
- Change Font Size 117
- Phone Services 118
- Line Settings 118

CHAPTER 10**Cisco Unified Video Camera 119**

- Install Cisco Unified Video Camera 119
 - Mount Camera on Phone 119
 - Mount Camera on Monitor 120
- View Camera Details 121
- Cisco Unified Video Camera Features 121
- Camera Lens Shutter 122
 - Close Camera Lens Shutter 122
- Camera Preferences 123
 - Enable Auto Transmit 123
 - Adjust Camera Brightness 124
 - Adjust Camera View Area 124
 - Access Preview Video 125
 - Enable Video 125
- Reset Camera 125

CHAPTER 11**Accessories 127**

- Accessory Support 127
- Important Headset Safety Information 128
- View Accessories List 128
- View Accessories Details 129
- USB Devices 129
- Set Up Wideband for Analog Headset 130
- Bluetooth Headsets 130
 - Add Bluetooth Accessory 131
 - Connect Bluetooth Accessory 132
 - Turn on Bluetooth 132
 - Disconnect Bluetooth Accessory 133
 - Delete Bluetooth Accessory 133
- Cisco Unified IP Color Key Expansion Module 133
 - Cisco Unified IP Color Key Expansion Module Features 134
 - Place a Call on the Key Expansion Module 135
 - Key Expansion Module Button Setup 136
 - Adjust the Key Expansion Module Screen Brightness 136

CHAPTER 12**Frequently Asked Questions 137**

- Why Can't I See All Active Calls on My Phone? 138
- How Do I Redirect an Incoming Call? 138
- How Do I Silence a Ringing Call If I'm On a Call? 138
- How Do I Resume a Call that is On Hold? 138
- What Is the Difference Between Buttons on the Left and Those on the Right of the Screen? 139
- Why Do Softkeys Keep Changing? 139
- What Is the Best Way to Look at Calls When I Have a Shared Line or Multiple Lines? 139
- What Should I Do If I Accidentally Press a Button While on a Call? 140
- How Do I Check Missed Calls? 140
- How Do I Exit from a Running Application? 140
- How Do I Connect Two Calls and then Drop from the Line Myself? 141
- What Does the Swap Softkey Do? 141
- How Do I Cancel a Conference or Transfer After I Start It? 142

How Can I Combine Two Calls Into a Single Conference Call?	142
Where Should I Mount My Cisco Unified Video Camera?	142
How Can I Prevent Theft of my Cisco Unified Video Camera?	142
Why can I not see video on a call?	143
What Does the Preview Softkey Do?	143
What Happens to Video When I Put a Call On Hold?	143
What Do the Light Colors on My Cisco Unified Video Camera Indicate?	144
How Do I Close the Shutter on my Cisco Unified Video Camera?	144
Why Does the Video on my Cisco Unified Video Camera Appear Too Dark?	144
Why Does My Phone Not Wake Up?	144
What Do Four Rings in Succession Mean?	145
Why Can't I Turn On VXC?	145
Why Is the VXC VPN Status "Not Connected"?	145
Why Does VXC Show a "Session Lost" Error?	146

CHAPTER 13
Troubleshooting 147

Missing Alert Calls Button	147
Missing All Calls Button	147
Cannot Sign In to the Personal Directory	148
Cannot Access the Self Care Portal	148
Security Error Message	148
Report Call Quality Issues	149
Documentation, Service Requests, and Additional Information	149

CHAPTER 14
Product Safety and Security 151

Safety and Performance Information	151
Power Outage	151
External Devices	151
Bluetooth Wireless Headset Performance	152
Ways to Provide Power to Your Phone	152
Phone Behavior During Times of Network Congestion	152
Compliance Statements	153
Compliance Statements for the European Union	153
CE Marking	153
Compliance Statements for Canada	153

- Compliance Information for Brazil 153
 - FCC Compliance Statements 153
 - FCC Part 15.19 Statement 154
 - FCC Part 15.21 Statement 154
 - FCC RF Radiation Exposure Statement 154
 - FCC Receivers and Class B Digital Statement 154
- Cisco Product Security Overview 154
- Important Online Information 155

CHAPTER 15

- Warranty 157**
 - Cisco One-Year Limited Hardware Warranty Terms 157



Getting Started

- [Accessibility Features](#), page 1
- [Cisco Unified IP Phone 8961](#), page 1
- [Cisco Unified IP Phone 9951](#), page 10
- [Cisco Unified IP Phone 9971](#), page 19
- [Power Save and Power Save Plus](#), page 28
- [Additional Information](#), page 29

Accessibility Features

The Cisco Unified IP Phones 8961, 9951, and 9971 provide accessibility features for the vision impaired, the blind, and the hearing and mobility impaired.

For detailed information about the accessibility features on these phones, see [Accessibility Features for the Cisco Unified IP Phone 8961, 9951, and 9971](#).

You can also find more information about accessibility at this Cisco website:

<http://www.cisco.com/web/about/responsibility/accessibility/index.html>

Cisco Unified IP Phone 8961

The following sections describe attributes of the Cisco Unified IP Phone 8961.

Phone Connections for Cisco Unified IP Phone 8961

Connect your phone to the corporate IP telephony network, using the following diagram.

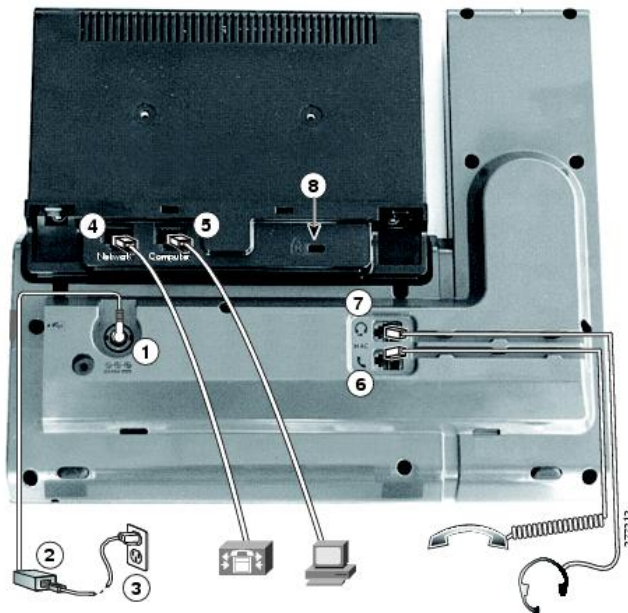

1	DC adapter port (DC48V)	5	Computer port (10/100/1000 PC) connection
2	AC-to-DC power supply (optional)	6	Handset connection
3	AC power wall plug (optional)	7	Analog headset connection (headset optional)
4	Network port (10/100/1000 SW) with IEEE 802.3af and 802.3at power enabled	8	Anti-theft security lock connector (lock optional)

The following diagram shows the phone from the side.



1	USB port	2	Accessory connector; for example, to connect a Cisco Unified IP Color Key Expansion Module
---	----------	---	--

**Note**

Each USB port supports the connection of up to five supported and nonsupported devices. Each device connected to the phone is included in the maximum device count. For example, the USB port on your phone can support a maximum of five USB devices (such as three Cisco Unified IP Color Key Expansion modules, one hub, and one other standard USB device). Many third-party USB products count as multiple USB devices, for example, a device containing USB hub and headset can count as two USB devices. For more information, see the USB device documentation.







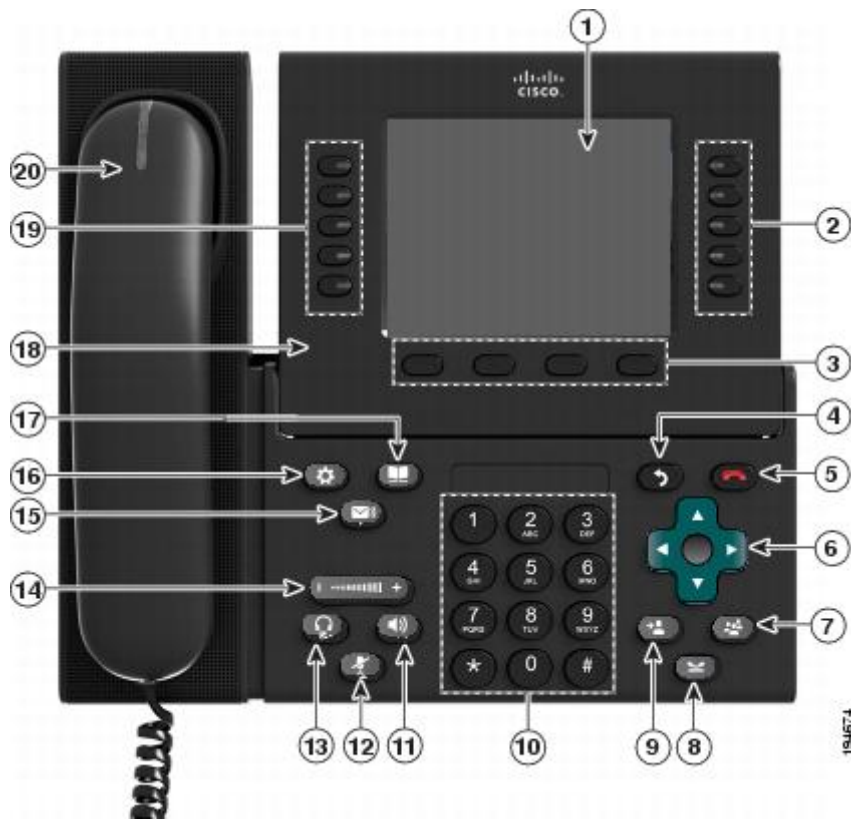

Buttons and Hardware









Your phone provides quick access to your phone lines, features, and call sessions:









- Programmable feature buttons (left side): Use to view calls on a line or access features such as Speed Dial or All Calls. (These buttons are also called feature buttons.)
- Session buttons (right side): Use to perform tasks such as answering a call, resuming a held call, or (when not being used for an active call) initiating phone functions such as displaying missed calls. Each call on your phone is associated with a session button.



1	Phone screen	Shows information about your phone, including directory number, call information (for example, caller ID, icons for an active call or call on hold) and available softkeys.
---	--------------	---

2	<p>Session buttons</p> 	<p>Each button corresponds with an active call or a call function. When you press the button, the action depends on the state of the phone:</p> <ul style="list-style-type: none"> • Active calls: Causes the phone to take the default action for an active call. For example, if you press the session button for a ringing call, the call is answered and if you press the button on a held call, the call resumes. Session information, such as caller ID and call duration, appears on the phone screen next to the session button. • Call functions: When a session button is not being used for an active call, it can be used to initiate functions on the phone, as indicated by the adjacent phone screen icons. For example, press the session button to display missed calls, take the phone off hook, or dial your voicemail system (with a Voicemail icon). <p>Color LEDs reflect the call state. LEDs can <i>flash</i> (blink on and off rapidly), <i>pulse</i> (alternately dim and brighten), or appear solid (glow without interruption).</p> <ul style="list-style-type: none"> • Flashing amber : Ringing call. Press this button to answer the call. • Solid green : May be a connected call or an outgoing call that is not yet connected. If the call is connected, press this button to display the call details or the participants of a conference call. If the call is not yet connected, press this button to end the call. • Pulsing green : Held call. Press this button to resume the held call. • Solid red : Shared line is in use remotely. Press this button to barge into call (if Barge is enabled). • Pulsing red : Shared line call put on hold remotely. Press this button to resume the held call. <p>The positions of the session buttons and feature buttons can be reversed on phones that use a locale with a right-to-left reading orientation, such as Hebrew and Arabic.</p>
3	<p>Softkey buttons</p> 	<p>Allow you to access the softkey options (for the selected call or menu item) displayed on your phone screen.</p>
4	<p>Back button</p> 	<p>Returns to the previous screen or menu.</p>
5	<p>Release button</p> 	<p>Ends a connected call or session.</p>

6	<p>Navigation pad and Select button</p> 	<p>The four-way Navigation pad allows you to scroll through menus, highlight items, and move within a text input field.</p> <p>The Select button (center of the Navigation pad) allows you to select a highlighted item.</p> <p>The Select button is lit (white) when the phone is in Power Save or Power Save Plus mode. Press the Select button to override Power Save and Power Save Plus mode.</p>
7	<p>Conference button</p> 	<p>Creates a conference call.</p>
8	<p>Hold button</p> 	<p>Places a connected call on hold and toggles between an active and held call.</p>
9	<p>Transfer button</p> 	<p>Transfers a call.</p>
10	<p>Keypad</p>	<p>Allows you to dial phone numbers, enter letters, and choose menu items by entering the item number.</p>
11	<p>Speakerphone button</p> 	<p>Selects the speakerphone as the default audio path and initiates a new call, picks up an incoming call, or ends a call. During a call, the button is lit green.</p> <p>The speakerphone audio path does not change until you select a new default audio path (for example, by picking up the handset).</p> <p>If external speakers are connected, the Speakerphone button selects them as the default audio path.</p>
12	<p>Mute button</p> 	<p>Toggles the microphone on or off during a call. When the microphone is muted, the button is lit red. When muted, you can hear the other parties on the call, but they cannot hear you.</p>
13	<p>Headset button</p> 	<p>Selects the headset as the default audio path and initiates a new call, picks up an incoming call, or ends a call. During a call, the button is lit green.</p> <p>A headset icon  in the phone screen header line indicates that the headset is the default audio path. This audio path does not change until you select a new default audio path (for example, by picking up the handset).</p>

14	Volume button 	Controls the handset, headset, and speakerphone volume (off hook) and the ringer volume (on hook). Silences the ringer on the phone if an incoming call is ringing.
15	Messages button 	Autodials your voicemail system (varies by system).
16	Applications button 	Opens/closes the Applications menu. Depending on how your system administrator sets up the phone, use it to access applications such as call history, preferences, and phone information.
17	Contacts button 	Opens/closes the Contacts menu. Depending on how your system administrator sets up the phone, use it to access personal directory, corporate directory, or call history.
18	Phone display	Can be positioned to your preferred viewing angle.
19	Programmable feature buttons (also called feature buttons) 	<p>Each button corresponds with a phone line, speed dial, or calling feature.</p> <p>Press a phone line button to display the active calls for that line.</p> <p>If you have multiple lines, you may have an All Calls button that displays a consolidated list of all calls from all lines (oldest at the top). If you do not see the All Calls button, your system administrator may have set up the primary line to automatically display all calls. For information on your set up, contact your system administrator.</p> <p>Color LEDs indicate the line state:</p> <ul style="list-style-type: none"> • Amber : Ringing call on this line • Green : Active or held call on this line • Red : Shared line in use remotely <p>The positions of the session buttons and feature buttons can be reversed on phones that use a locale with a right-to-left reading orientation, such as Hebrew and Arabic.</p>
20	Handset with light strip	The handset light strip lights up to indicate a ringing call (flashing red) or a new voice message (steady red).

Phone with Single Line

The way that your system administrator set up your phone determines what is displayed on your phone screen.



1	Line label	Displays the line phone information.
2	Header	Displays the date, time, and other information (such as phone number) about the selected line. If you are on a call and highlight the header instead of a call, the displayed softkeys are the same as those that display when the phone is idle. This is useful, for example, if you want to access the Forward All or New Call softkeys while you are on a call.
3	Session button label (for connected call)	Displays information (such as phone number and duration) about a connected call on the line. The timer counts the call duration in minutes and seconds (MM:SS) until the call exceeds 60 minutes. Then the timer counts hours and minutes (HH:MM).
4	Session button label (for held call)	Displays information (such as phone number and duration) about a held call on the line. Press the corresponding session button to resume the held call. The timer counts the call duration in minutes and seconds (MM:SS) until the call exceeds 60 minutes. Then the timer counts hours and minutes (HH:MM).
5	New Call icon	Indicates you can press the corresponding session button to make a new call.
6	Softkeys	Softkey options for the selected (highlighted) call only. If you select a different call (for example, you press a feature button, press the Navigation pad, or answer a ringing call), the softkey options may change.

Phone with Multiple Lines

The way that your system administrator set up your phone determines what is displayed on your phone screen.

If you have multiple lines, you may find it useful to use All Calls to view all calls on all lines. Your system administrator can also set up your Primary Line key to automatically display all calls on all lines.

If you handle many calls at one time, use Answer to answer the oldest incoming call without having to scroll down the call list and select the call.

For more information, contact your system administrator.



1	Primary line label	Displays information about the primary phone line. Look for the blue icon on the line label to see which line is selected. In this case, the primary line is selected, and the information displayed is for the primary line only.
2	Header	Displays the date, time, and other information (such as phone number) about the selected line. If you are on a call and highlight the header instead of a call, the displayed softkeys are the same as those that display when the phone is idle. This is useful, for example, if you want to access the Forward All or New Call softkeys while you are on a call.)
3	Session label (with Connected Call icon)	Displays information (such as call status and duration) about a connected call associated with the selected line.
4	Session labels (with Held Call icons)	Display information (such as call status and duration) about held calls associated with the selected line. Calls are displayed on the right side of the phone screen from the oldest (at the top) to the newest. Press the session button next to a Held Call icon to resume the held call for that session.

5	Softkeys	<p>Softkey options for the selected call only.</p> <p>If you select a different call (for example, you press a feature button or the Navigation pad, or answer a ringing call), the softkey options may change.</p>
6	Answer label	<p>Displays if your system administrator has assigned the Answer feature to the programmable feature button.</p> <p>Press this label or the corresponding button to answer the oldest incoming call without having to scroll down the call list and select the call.</p>
7	Speed-dial label	<p>Displays if you or your system administrator assigned a speed dial to the programmable feature button. This is useful if you tend to have more than five active calls on your phone.</p>
8	Nonprimary line labels	<p>Display calls and information about nonprimary phone lines.</p>
9	All Calls label	<p>Displays if the All Calls feature is enabled. Press the corresponding button to display all calls on all lines.</p> <p>Calls are displayed on the right side of the phone screen from the oldest (at the top) to the newest.</p> <p>When you are on a call, press All Calls once to select the current call or the first call on the list; press All Calls twice to select the header. With the header selected, the displayed softkeys are the same as those that display when the phone is idle. This is useful, for example, if you have multiple calls on your phone and want to access the New Call softkey.</p> <p>Using the All Calls feature is recommended if you have multiple lines on your phone.</p> <p>Your system administrator can also set up your phone so that the primary line key displays the same list as All Calls. For more information, contact your system administrator.</p>

Cisco Unified IP Phone 9951

The following sections describe attributes of the Cisco Unified IP Phone 9951.

Phone Connections for Cisco Unified IP Phone 9951

Connect your phone to the corporate IP telephony network, using the following diagram.

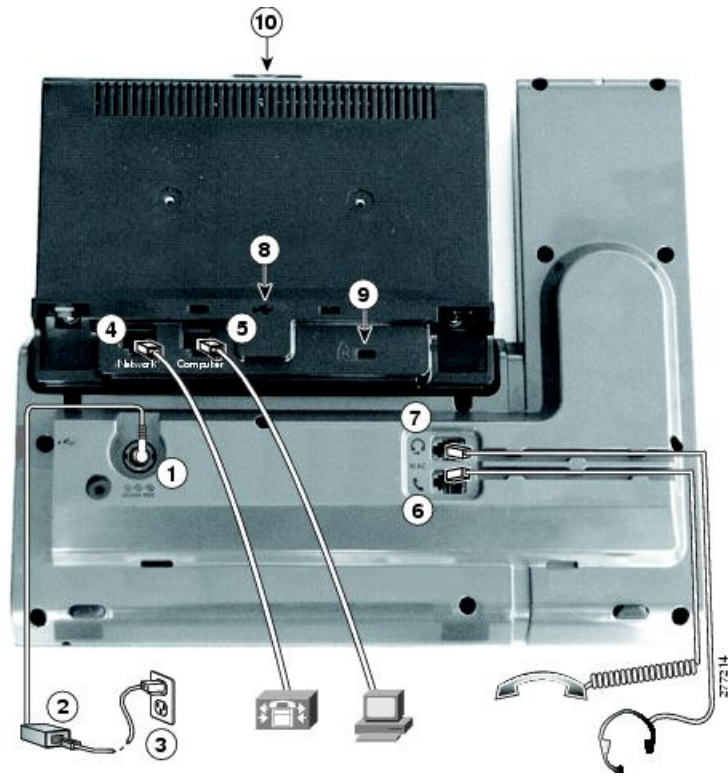

1	DC adapter port (DC48V)	6	Handset connection
2	AC-to-DC power supply (optional for the network port connection but required for a wifi connection)	7	Analog headset connection (headset optional)
3	AC power wall plug (optional)	8	USB port
4	Network port (10/100/1000 SW) with IEEE 802.3af and 802.3at power enabled	9	Anti-theft security connector (lock optional)
5	Computer port (10/100/1000 PC) connection	10	Camera pin holes (for Cisco Unified Video Camera)

The following picture shows the side of the phone.



1	USB port	3	Speaker port for output to optional external speakers
2	Accessory connector; for example, for connecting a Cisco Unified IP Phone Expansion Module	4	Microphone port for input from optional external microphone

**Note**

Each USB port supports a maximum of five supported and nonsupported devices that are connected to the phone. Each device connected to the phone is included in the maximum device count. For example, your phone can support five USB devices such as three Cisco Unified IP Color Key Expansion modules, one hub, and one other standard USB device on the side port and five additional standard USB devices on the back port. Many third-party USB products count as multiple USB devices, for example, a device containing USB hub and headset can count as two USB devices. For more information, see the USB device documentation.

Bluetooth

Your phone supports Bluetooth Class 2 technology when the headsets support Bluetooth. You can add and pair up to five Bluetooth headsets to your phone, but the last Bluetooth headset connected becomes the default for use with the phone.

Buttons and Hardware







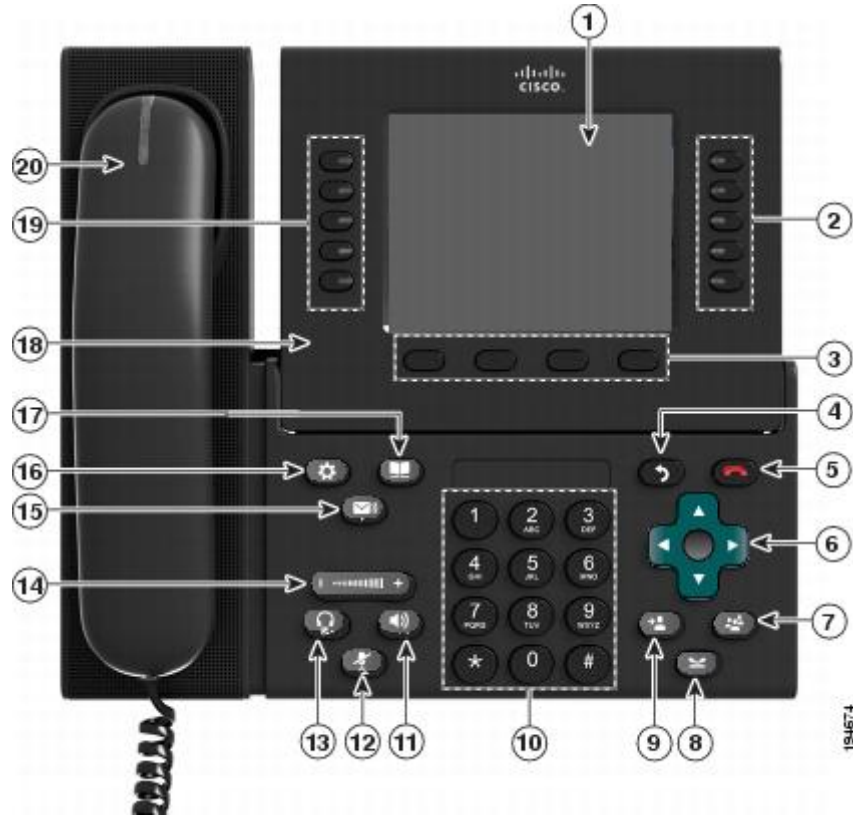

Your phone provides quick access to your phone lines, features, and call sessions:









- Programmable feature buttons (left side): Use to view calls on a line or access features such as Speed Dial or All Calls. These buttons are also called feature buttons.









- Session buttons (right side): Use to perform tasks such as answering a call, resuming a held call, or (when not being used for an active call) initiating phone functions such as displaying missed calls. Each call on your phone is associated with a session button.



1	Phone screen	Shows information about your phone, including directory number, call information (for example, caller ID, icons for an active call or call on hold) and available softkeys.
---	--------------	---

2	<p>Session buttons</p> 	<p>Each button corresponds with an active call or a call function. When you press the button, the action depends on the state of the phone:</p> <ul style="list-style-type: none"> • Active calls: Press the button to take the default action for an active call. For example, press the session button for a ringing call to answer the call and press the button on a held call to resume the call. Session information, such as caller ID and call duration, appears on the phone screen next to the session button. • Call functions: When a session button is not being used for an active call, it can be used to initiate functions on the phone, as indicated by the adjacent phone screen icons. For example, press the session button to display missed calls, take the phone off hook, or dial your voicemail system (with a Voicemail icon). <p>Color LEDs reflect the call state. LEDs can <i>flash</i> (blink on and off rapidly), <i>pulse</i> (alternately dim and brighten), or appear solid (glow without interruption).</p> <ul style="list-style-type: none"> • Flashing amber : Ringing call. Press this button to answer the call. • Solid green : May be a connected call or an outgoing call that is not yet connected. If the call is connected, press this button to display the call details or the participants of a conference call. If the call is not yet connected, press this button to end the call. • Pulsing green : Held call. Press this button to resume the held call. • Solid red : Shared line in use remotely. Press this button to barge into the call (if Barge is enabled). • Pulsing red : Shared line call put on hold remotely. Press this button to resume the held call. <p>The positions of the session buttons and feature buttons can be reversed on phones that use a locale with a right-to-left reading orientation, such as Hebrew and Arabic.</p>
3	<p>Softkey buttons</p> 	<p>Allow you to access the softkey options (for the selected call or menu item) displayed on your phone screen.</p>
4	<p>Back button</p> 	<p>Returns to the previous screen or menu.</p>
5	<p>Release button</p> 	<p>Ends a connected call or session.</p>

6	<p>Navigation pad and Select button</p> 	<p>The four-way Navigation pad allows you to scroll through menus, highlight items, and move within a text input field.</p> <p>The Select button (center of the Navigation pad) allows you to select a highlighted item.</p> <p>The Select button is lit (white) when the phone is in Power Save or Power Save Plus mode. Press the Select button to override Power Save and Power Save Plus mode.</p>
7	<p>Conference button</p> 	<p>Creates a conference call.</p>
8	<p>Hold button</p> 	<p>Places a connected call on hold and toggles between an ongoing and held call.</p>
9	<p>Transfer button</p> 	<p>Transfers a call.</p>
10	<p>Keypad</p>	<p>Allows you to dial phone numbers, enter letters, and choose menu items by entering the item number.</p>
11	<p>Speakerphone button</p> 	<p>Selects the speakerphone as the default audio path and initiates a new call, picks up an incoming call, or ends a call. During a call, the button is lit green.</p> <p>The speakerphone audio path does not change until you select a new default audio path (for example, by picking up the handset).</p> <p>If external speakers are connected, the Speakerphone button selects them as the default audio path.</p>
12	<p>Mute button</p> 	<p>Toggles the microphone on or off during a call. When the microphone is muted, the button is lit red.</p> <p>When muted, you can hear the other parties on the call, but they cannot hear you.</p>
13	<p>Headset button</p> 	<p>Selects the headset as the default audio path and initiates a new call, picks up an incoming call, or ends a call. During a call, the button is lit green.</p> <p>A headset icon  in the phone screen header line indicates the headset is the default audio path. This audio path does not change until you select a new default audio path (for example, by picking up the handset).</p>

14	Volume button 	Controls the handset, headset, and speakerphone volume (off hook) and the ringer volume (on hook). Silences the ringer on the phone if an incoming call is ringing.
15	Messages button 	Autodials your voicemail system (varies by system).
16	Applications button 	Opens/closes the Applications menu. Depending on how your system administrator sets up the phone, use it to access applications such as call history, preferences, and phone information.
17	Contacts button 	Opens/closes the Contacts menu. Depending on how your system administrator sets up the phone, use it to access personal directory, corporate directory, or call history.
18	Phone display	Can be positioned to your preferred viewing angle.
19	Programmable feature buttons (also called feature buttons) 	Each button corresponds to a phone line, speed dial, and calling feature. Press a button for a phone line to display the active calls for that line. If you have multiple lines, you may have an All Calls button that displays a consolidated list of all calls from all lines (oldest at the top). If you do not see the All Calls button, your system administrator may have set up the primary line to automatically display all calls. For information on your set up, contact your system administrator. Color LEDs indicate the line state: <ul style="list-style-type: none"> • Amber : Ringing call on this line • Green : Active or held call on this line • Red : Shared line in-use remotely The position of the programmable feature buttons can be reversed with the position of the session buttons on phones that use a locale with a right-to-left reading orientation, such as Hebrew and Arabic.
20	Handset with light strip	The handset light strip lights up to indicate a ringing call (flashing red) or a new voice message (steady red).

Phone with Single Line

The way that your system administrator set up your phone determines what is displayed on your phone screen.



1	Line label	Displays the line phone information.
2	Header	Displays the date, time, and other information (such as phone number) about the selected line.
3	Session button label (for connected call)	Displays information (such as phone number and duration) about a connected call on the line. The timer counts the call duration in minutes and seconds (MM:SS) until the call exceeds 60 minutes. Then the timer counts hours and minutes (HH:MM).
4	Session label (for held call)	Displays information (such as phone number and duration) about a held call on the line. Press the corresponding session button to resume the held call. The timer counts the call duration in minutes and seconds (MM:SS) until the call exceeds 60 minutes. Then the timer counts hours and minutes (HH:MM).
5	New Call icon	Indicates you can press the corresponding session button to make a new call.
6	Softkeys	Softkey options for the selected (highlighted) call only. If you select a different call (for example, you press a feature button, press the Navigation pad, or answer a ringing call), the softkey options may change.

Phone with Multiple Lines

The way that your system administrator set up your phone determines what is displayed on your phone screen.

If you have multiple lines, you can use All Calls to view all calls on all lines. Your system administrator can also set up your primary line key to automatically display all calls on all lines.

If you handle many calls at one time, use Answer to answer the oldest incoming call without having to scroll down the call list and select the call.

For more information, contact your system administrator.



1	Primary line label	Displays information about the primary phone line. Look for the blue icon on the line label to see which line is selected. In this case, the primary line is selected, and the information displayed is for the primary line only.
2	Header	Displays the date and time, and information (such as phone number) about the selected line.
3	Session label (with Connected Call icon)	Displays information (such as call status and duration) about a connected call associated with the selected line. The timer counts the call duration in minutes and seconds (MM:SS) until the call exceeds 60 minutes. Then the timer counts hours and minutes (HH:MM).
4	Session label (with Held Call icon)	Display information (such as call status and duration) about held calls associated with the selected line. Calls are displayed on the right side of the phone screen from the oldest (at the top) to the newest. Press the session button next to a Held Call icon to resume the held call for that session. The timer counts the call duration in minutes and seconds (MM:SS) until the call exceeds 60 minutes. Then the timer counts hours and minutes (HH:MM).
5	Softkeys	Softkey options for the selected call only. If you select a different call (for example, you press a feature button, press the Navigation pad, or answer a ringing call), the softkey options may change.

6	Answer label	<p>Displays if your system administrator has assigned the Answer feature to the programmable feature button.</p> <p>Press this label or the corresponding button to answer the oldest incoming call without having to scroll down the call list and select the call.</p>
7	Speed-dial label	<p>Displays if you or your system administrator assigned a speed dial to the programmable feature button.</p>
8	Nonprimary line labels	<p>Display information about nonprimary phone lines.</p>
9	All Calls label	<p>Displays if the All Calls feature is enabled. Press the corresponding button to display all calls on all lines.</p> <p>Calls are displayed on the right side of the phone screen from the oldest (at the top) to the newest.</p> <p>Press the button once to select the current call or first call on the list. Press the button twice to select the header line, which allows you to make a new call.</p> <p>With multiple lines, you may prefer the All Calls view.</p> <p>Your system administrator can also set up your phone so that the primary line key displays the same list as the All Calls button. For more information, contact your system administrator.</p>

Cisco Unified IP Phone 9971

The following sections describe attributes of the Cisco Unified IP Phone 9971.

Phone Connections for Cisco Unified IP Phone 9971

Connect your phone to the corporate IP telephony network, using the following diagram.

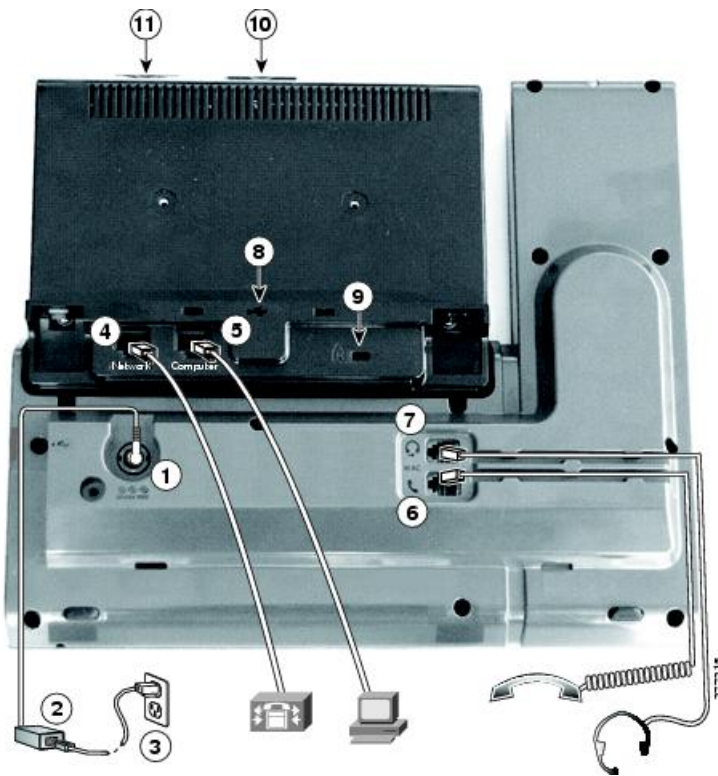

1	DC adapter port (DC48V)	7	Analog headset connection (optional)
2	AC-to-DC power supply (optional for the network port connection but required for a Wi-Fi connection)	8	USB port
3	AC power wall plug (optional)	9	Anti-theft security lock connector (lock optional)
4	Network port (10/100/1000 SW) with IEEE 802.3af and 802.3at power enabled	10	Camera pin holes (for Cisco Unified Video Camera)
5	Computer port (10/100/1000 PC) connection	11	Secure Digital I/O (SDIO) slot (not used for this release)
6	Handset connection		

The following picture shows the side of the phone.



1	USB port	3	Speaker port for output to optional external speakers
2	Accessory connector; for example, for connecting a Cisco Unified IP Phone Expansion Module	4	Microphone port for input from optional external microphone

**Note**

Each USB port supports the connection of up to five supported and nonsupported devices. Each device connected to the phone is included in the maximum device count. For example, your phone can support five USB devices (such as three Cisco Unified IP Color Key Expansion modules, one hub, and one other standard USB device) on the side port and five additional standard USB devices on the back port. Many third-party USB products count as multiple USB devices, for example, a device containing USB hub and headset can count as two USB devices. For more information, see the USB device documentation.

Wireless Connection and Bluetooth

Your phone can be connected to a wireless network using 802.11a or 802.11b/g, but your system administrator sets up the connection. For more information, contact your system administrator.

Your phone supports Bluetooth Class 2 technology when the headsets support Bluetooth. You can pair and connect up to five Bluetooth headsets to your phone, but the last Bluetooth headset connected becomes the default for use with the phone.

Buttons and Hardware







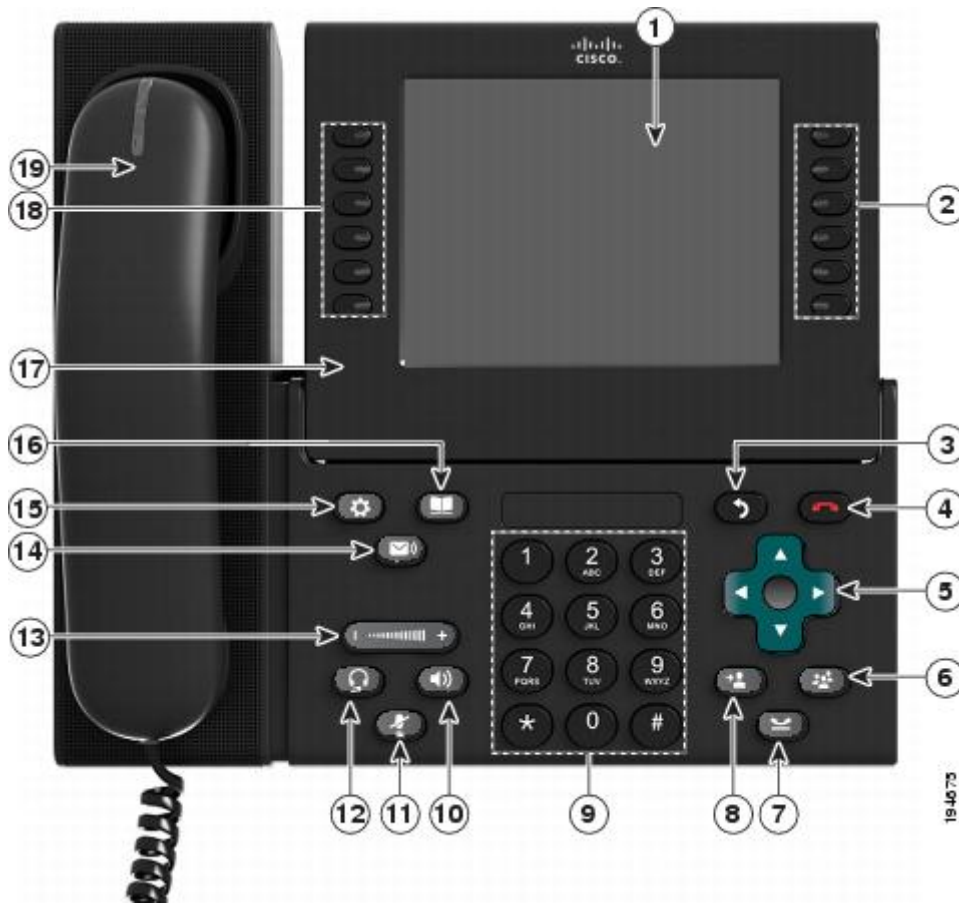

Your phone provides quick access to your phone lines, features, and call sessions:









- Use the feature buttons (on the left) to view calls on a line or access features such as Speed Dial or All Calls.









- Use the call session buttons (on the right) to perform tasks such as making a call, answering a call, or resuming a held call. Each call on your phone is associated with a session button.



1	Phone screen	Shows information about your phone, including directory number, call information (for example, caller ID, icons for an active call or call on hold) and available softkeys. Phone screen items, such as menu options and softkeys, are touch-sensitive.
---	--------------	--

2	<p>Session buttons</p> 	<p>Each button corresponds with an active call or a call function. When you press the button, the action depends on the state of the phone:</p> <ul style="list-style-type: none"> • Active calls: Press the button to take the default action for an active call. For example, press the session button for a ringing call to answer the call and press the button on a held call to resume the call. Session information, such as caller ID and call duration, appears on the phone screen next to the session button. • Call functions: When a session button is not being used for an active call, it can be used to initiate functions on the phone, as indicated by the adjacent phone screen icons. For example, press the session button to display missed calls, take the phone off hook, or dial your voicemail system (with a Voicemail icon). <p>Color LEDs reflect the call state. LEDs can <i>flash</i> (blink on and off rapidly), <i>pulse</i> (alternately dim and brighten), or appear solid (glow without interruption).</p> <ul style="list-style-type: none"> • Flashing amber : Ringing call. Press this button to answer the call. • Solid green : May be a connected call or an outgoing call that is not yet connected. If the call is connected, press this button to display the call details or the participants of a conference call. If the call is not yet connected, press this button to end the call. • Pulsing green : Held call. Press this button to resume the held call. • Solid red : Shared line in use remotely. Press this button to barge into the call (if Barge is enabled). • Pulsing red : Shared line call put on hold remotely. Press this button to resume the held call. <p>The positions of the session buttons and feature buttons can be reversed on phones that use a locale with a right-to-left reading orientation, such as Hebrew and Arabic.</p>
3	<p>Back button</p> 	<p>Returns to the previous screen or menu.</p>
4	<p>Release button</p> 	<p>Ends a connected call or session.</p>

5	Navigation pad and Select button 	<p>The four-way Navigation pad allows you to scroll through menus, highlight items, and move within a text input field.</p> <p>The Select button (center of the Navigation pad) allows you to select a highlighted item, disable the phone screen for cleaning, or enable the phone screen if it is in power-save mode.</p> <p>The Select button is lit (white) when the phone is in Power Save or Power Save Plus mode. Press the Select button to override Power Save and Power Save Plus mode.</p>
6	Conference button 	Creates a conference call.
7	Hold button 	Places a connected call on hold and toggles between an active and held call.
8	Transfer button 	Transfers a call.
9	Keypad	Allows you to dial phone numbers, enter letters, and choose menu items by entering the item number.
10	Speakerphone button 	<p>Selects the speakerphone as the default audio path and initiates a new call, picks up an incoming call, or ends a call. During a call, the button is lit green.</p> <p>The speakerphone audio path does not change until you select a new default audio path (for example, by picking up the handset).</p> <p>If external speakers are connected, the Speakerphone button selects them as the default audio path.</p>
11	Mute button 	<p>Toggles the microphone on or off during a call. When the microphone is muted, the button is lit red.</p> <p>When muted, you can hear the other parties on the call, but they cannot hear you.</p>
12	Headset button 	<p>Selects the wired or wireless headset as the default audio path and initiates a new call, picks up an incoming call, or ends a call. During a call, the button is lit green.</p> <p>A headset icon  in the phone screen header line indicates the headset is the default audio path. This audio path does not change until a new default audio path is selected (for example, by picking up the handset).</p>

13	Volume button 	Controls the handset, headset, and speakerphone volume (off hook) and the ringer volume (on hook). Silences the ringer on the phone if an incoming call is ringing.
14	Messages button 	Autodials your voicemail system (varies by system).
15	Applications button 	Opens/closes the Applications menu. Depending on how your system administrator sets up the phone, use it to access applications such as call history, preferences, and phone information.
16	Contacts button 	Opens/closes the Contacts menu. Depending on how your system administrator sets up the phone, use it to access personal directory, corporate directory, or call history.
17	Phone display	Can be positioned to your preferred viewing angle.
18	Programmable feature buttons (also called feature buttons) 	Correspond to phone lines, speed dials, and calling features. Press a button for a phone line to display the active calls for that line. If you have multiple lines, you may have an All Calls button that displays a consolidated list of all calls from all lines (oldest at the top). If you do not see the All Calls button, your system administrator may have set up the primary line to automatically display all calls. For information on your set up, contact your system administrator. Color LEDs indicate the line state: <ul style="list-style-type: none"> • Amber : Ringing call on this line • Green : Active or held call on this line • Red : Shared line in-use remotely The positions of the session buttons and feature buttons can be reversed on phones that use a locale with a right-to-left reading orientation, such as Hebrew and Arabic.
19	Handset with light strip	The handset light strip lights up to indicate a ringing call (flashing red) or a new voice message (steady red).

Phone with Single Line

The way that your system administrator set up your phone determines what is displayed on your phone screen.

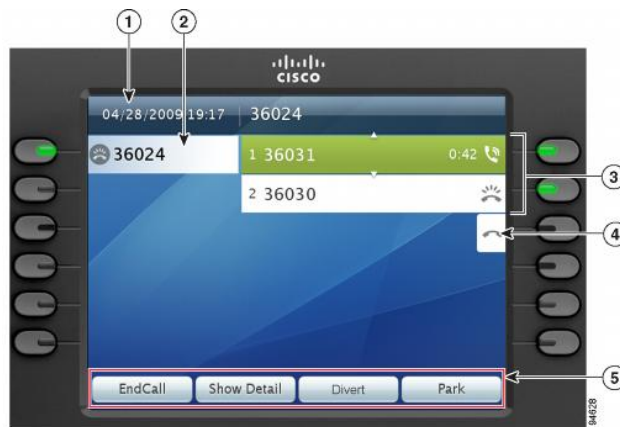

1	Header	Displays the date, time, and information (such as phone number) about the selected line.
2	Primary line label	Displays the primary line phone information.
3	Session label	Displays information (such as call status and duration) about active calls associated with the selected line. Calls are displayed in order of the oldest (at the top) to the newest. The timer counts the call duration in minutes and seconds (MM:SS) until the call exceeds 60 minutes. Then the timer counts hours and minutes (HH:MM).
4	New Call icon	A touch-sensitive icon you can press to make a new call.
5	Softkeys	Touch-sensitive softkey options for the selected (highlighted) call only. If you select a different call (for example, you press a feature button, press the Navigation pad, or answer a ringing call), the softkey options may change.

Phone with Multiple Lines

The way that your system administrator set up your phone determines what is displayed on your phone screen.

If you have multiple lines, you can use All Calls to view all calls on all lines. Your system administrator can also set up your primary line key to automatically display all calls on all lines.

If you handle many calls at one time, use Answer to answer the oldest incoming call without having to scroll down the call list and select the call.

For more information, contact your system administrator.



1	Header	Displays the date and time, and information (such as phone number) about the selected line. (If you are on a call and highlight the header instead of a call, the softkeys that display are the same as those that display when the phone is idle. This is useful, for example, if you want to access the Forward All or New Call softkeys while you are on a call.)
2	Session label (for connected call)	Displays information (such as call status and duration) about a connected call on the selected line. The timer counts the call duration in minutes and seconds (MM:SS) until the call exceeds 60 minutes. Then the timer counts hours and minutes (HH:MM).
3	Session label (for held call)	Display information (such as call status and duration) about held calls associated with the selected line. Calls are displayed on the right side of the phone screen from the oldest (at the top) to the newest. Press the session button next to a Held Call icon to resume the held call for that session. The timer counts the call duration in minutes and seconds (MM:SS) until the call exceeds 60 minutes. Then the timer counts hours and minutes (HH:MM).
4	Softkeys	Touch-sensitive softkey options.
5	Answer label	Displays if your system administrator has assigned the Answer feature to the programmable feature button. Press this label or the corresponding button to answer the oldest incoming call without having to scroll down the call list and select the call.
6	Speed-dial label	Displays if you or your system administrator assigned a speed dial to the programmable feature button.
7	Nonprimary line labels	Display information about nonprimary phone lines.

8	All Calls label	<p>Displays if the All Calls feature is enabled. Press the corresponding button to display all calls on all lines.</p> <p>Calls are displayed on the right side of the phone screen from the oldest (at the top) to the newest.</p> <p>When you are on a call, press All Calls once to select the current call or the first call on the list; press All Calls twice to select the header. With the header selected, the softkeys that display are the same as those that display when the phone is idle. This is useful, for example, if you have multiple calls on your phone and want to access the New Call softkey.</p> <p>Using the All Calls feature is recommended highly if you have multiple lines on your phone.</p>
9	Primary line label	<p>Displays information about the primary phone line.</p> <p>Look for the blue icon on the line label to see which line is selected. In this case, the primary line is selected, and the information displayed is for the primary line only.</p> <p>Your system administrator can also set up your phone so that the primary line key displays the same list as the All Calls button. For more information, contact your system administrator.</p>

Power Save and Power Save Plus

Your administrator can set up these energy-saving modes:

- Power Save
- Power Save Plus

Power Save

Depending on how your administrator sets up your phone, the phone display may go into a power-save mode. In power-save mode the phone screen appears blank and the **Select** button is lit white.

To turn on the phone display, press any button or lift the handset.

Power Save Plus

Your phone supports Cisco EnergyWise (EW), which is also known as power save plus. Your administrator sets up sleep (power down) and wake (power up) times for your phone to save energy. If your phone goes into power save plus, the **Select** button is lit white.

Ten minutes before the scheduled sleep time, the **Select** button lights up; you receive a message that your phone will power off at a specific time. If configured, you may also hear a ringtone. The ringtone plays according to the following schedule:

- At 10 minutes before power off, the ringtone plays four times
- At 7 minutes before power off, the ringtone plays four times
- At 4 minutes before power off, the ringtone plays four times
- At 30 seconds before power off, the ringtone plays 15 times or until the phone powers off

If your phone is inactive (idle) at the sleep time, a message reminds you that your phone is about to power down. To keep the phone active, press **OK** in the message or any key on the phone.

If your phone is active, it waits until it has been inactive for a while before telling you of the pending power shutdown.

After your phone goes to sleep, press **Select** to wake it up. At the configured wake time, your phone powers up.

Wake and sleep times are also linked to the configured days that you normally work. If your requirements change (for example, your work hours or work days change), contact your administrator to have your phone reconfigured.

Additional Information

You can access the Cisco website at this URL: <http://www.cisco.com/>

Within the Cisco website, you can find the following information:

- Cisco Unified IP Phone 9951 and 9971 quick reference cards, quick start guides, and end-user guides:
http://cisco.com/en/US/products/ps10453/products_user_guide_list.html
- Cisco Unified IP Phone 8961 quick reference cards, quick start guides, and end-user guides:
http://www.cisco.com/en/US/products/ps10451/products_user_guide_list.html
- Licensing information:
http://cisco.com/en/US/products/ps10453/products_licensing_information_listing.html
- Cisco international websites:
Allows access to international Cisco websites from <http://www.cisco.com/> by clicking the Worldwide [change] link at the top of the web page.



CHAPTER 2

Phone Setup

- [Connect Footstand, page 31](#)
- [Adjust Phone Display Viewing Angle, page 32](#)
- [Adjust the Handset Rest, page 33](#)
- [Secure the Phone with a Cable Lock, page 34](#)

Connect Footstand

If your phone is placed on a table or desk, connect the footstand to the back of the phone.

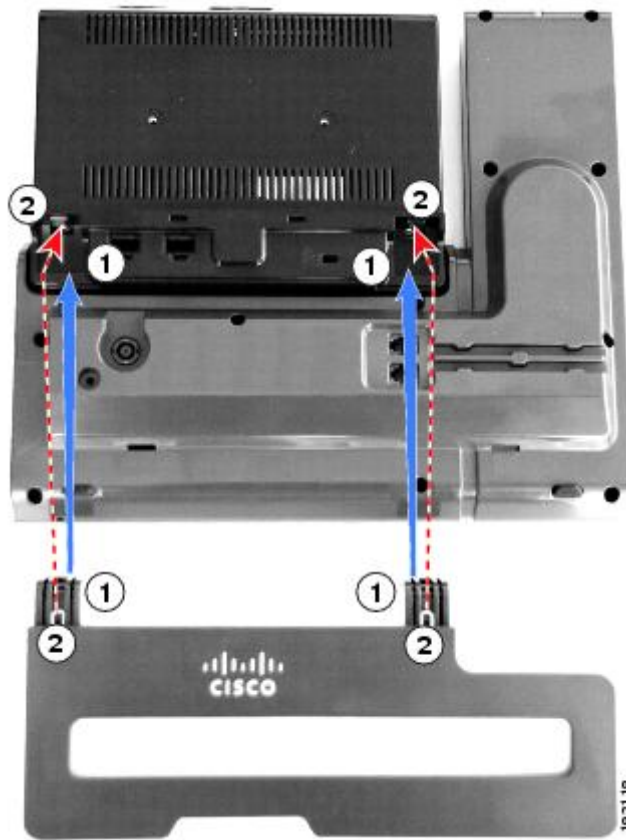

Procedure

Step 1 Insert the curved connectors into the lower slots.

Step 2 Lift the footstand until the connectors snap into the upper slots.

Note Connecting and disconnecting the footstand may require a little more force than you expect.

Adjust Phone Display Viewing Angle

The viewing angle of the phone display can be adjusted according to your preference.

Procedure

Hold the handset and cradle with your left hand, hold the right side of the bezel (to the right of the display) with your right hand, and then move your hands back and forth in opposite directions to adjust the angle. The following figure shows the display angle of the Cisco Unified IP Phone 9971.



Adjust the Handset Rest

If your phone is wall-mounted or if the handset slips out of the cradle too easily, you may need to adjust the handset rest to ensure that the receiver does not slip out of the cradle.

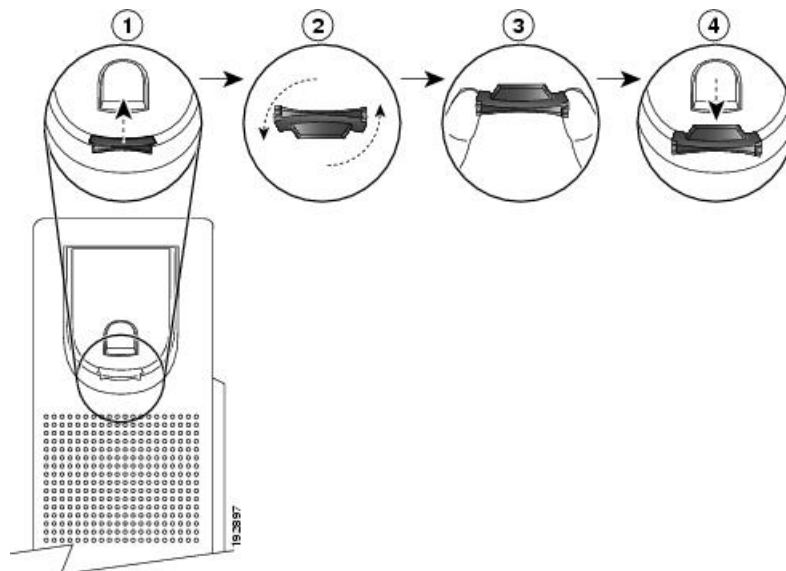

Procedure

-
- Step 1** Remove the handset from the cradle and pull the plastic tab from the handset rest.
 - Step 2** Rotate the tab 180 degrees.
 - Step 3** Hold the tab between two fingers, with the corner notches facing you.
 - Step 4** Line up the tab with the slot in the cradle and press the tab evenly into the slot. An extension protrudes from the top of the rotated tab.
 - Step 5** Return the handset to the handset rest.
-

Secure the Phone with a Cable Lock

You can secure your phone with a laptop cable lock up to 20 mm wide.

Procedure

- Step 1** Take the looped end of the cable lock and wrap it around the object to which you want to secure your phone.
 - Step 2** Pass the lock through the looped end of the cable.
 - Step 3** Unlock the cable lock.
 - Step 4** Press and hold the locking button to align the locking teeth.
 - Step 5** Insert the cable lock into the lock slot of your phone and release the locking button.
 - Step 6** Lock the cable lock.
-



Basic Operations

- [Clean the Phone Screen, page 35](#)
- [Clean the Phone Touchscreen Display, page 36](#)
- [Make Calls, page 36](#)
- [Navigate and Select Items, page 40](#)
- [View All Calls on Phone, page 40](#)
- [Answer Calls, page 41](#)
- [Answer Calls Automatically, page 43](#)
- [Answer Call Waiting, page 44](#)
- [Manage Calls, page 44](#)
- [Call Forward, page 46](#)
- [Mute Phone, page 46](#)
- [Hold Call, page 47](#)
- [Get Notified When a Contact is Available, page 48](#)
- [Call Park, page 49](#)
- [Intercom Calls, page 51](#)
- [Video Calls, page 52](#)
- [View Phone Information, page 54](#)
- [Sign In to the Cisco Unified Communications Self Care Portal, page 55](#)

Clean the Phone Screen

Procedure

If your phone screen gets dirty, wipe it with a soft, dry cloth.

Caution Do not use any liquids or powders on the phone because they can contaminate the phone components and cause failures.

Clean the Phone Touchscreen Display

When the phone has a touchscreen, the touchscreen needs to be inactive before you clean the display.



Caution



Use only a soft, dry cloth to wipe the phone display. Do not use any liquids or powders on the phone because they can contaminate phone components and cause failures.

Procedure

-
- Step 1** If the phone is in sleep mode, press **Select** so that the phone wakes up.
- Step 2** Press and hold **Select** until you see the message `Touchscreen Disabled` to disable the phone screen. The phone screen reenables automatically after 60 seconds.
- Step 3** Clean the display using a soft, dry cloth.
- Step 4** To reenables the phone screen manually after cleaning, press **Select** until you see the message `Touchscreen Enabled`.
-

Make Calls

Here are some easy ways to place a call on your Cisco Unified IP Phone.

- You can dial on-hook, without a dial tone (predial). To predial, enter a number, then go off-hook by lifting the handset, or pressing Dial, , or .
- Press Turn On to enable the Enable Video On/Off feature, or press Return to return to the Setup screen.



Note

- If parties on a call hear a beep tone, the call may be monitored or recorded. For more information, contact your system administrator.
 - Your phone may be set up for international call logging, which is indicated by a “+” symbol on the call history, redial, or call directory entries. For more information, contact your system administrator.
 - If Confidential Access Level (CAL) is enabled, you may see different messages about your call. If your call fails due to an incompatible CAL, you see a failure message. For more information, contact your administrator.
-

Make a Call with the Speakerphone

Your administrator can configure your phone to disable the speakerphone.

Procedure

- Step 1** Press **Speakerphone** .
- Step 2** Enter a number.
-

Place Call Using Headset

Procedure

- Step 1** If the headset button is lit, press **New Call** and enter a number.
- Step 2** If the headset button is not lit, press  and enter a number.
-

Release Call and Start Another Call

When you are on an active call or dialing, and want to release the call, the following actions occur:

- The active call ends
- The phone provides dial tone
- The New Call displays

Procedure

- Step 1** When you are on an active call or while dialing, press **Release**.
- Step 2** Enter the required number and press **Dial**.
-

Dial Number On-Hook

On-hook dialing allows you to enter a phone number before getting a dial tone and lift the handset to complete the call.

Your system administrator can enable your phone to check your Call History records and display the closest matches while you are entering the number. For example, if your Call History has the entry 987-6543, this entry displays as you enter the digits 987. When the desired number displays, you can select it to place the call to that number.

Procedure

- Step 1** Enter or speed-dial a phone number.
The On-Hook Dialing screen displays.
 - Step 2** Press **Call**. If you are specifying an Abbreviated Dial, enter the abbreviated number and then press **Speed Dial**.
 - Step 3** Lift the handset, or press **Speakerphone** or **Headset**.
 - Step 4** If you hear a tone and see the message `Enter Authorization Code`, enter the Forced Authorization Code (FAC) given to you by your system administrator.
 - Step 5** If you hear a tone and see the message `Enter Client Matter Code`, enter the Client Matter Code (CMC) given to you by your system administrator.
If authorized by the system, the call proceeds.
-

Dial an International Number

You can dial international calls when you prefix the phone number with a plus (+) sign.

Procedure

- Step 1** Press and hold **star (*)** for at least 1 second.
The plus (+) sign is displayed as the first digit in the phone number.
 - Step 2** Enter the phone number.
 - Step 3** Press **Call** or wait 10 seconds after the last key press to automatically place the call.
-

Redial a Number

You can call the most recently dialed phone number.

Procedure

Press **Redial**.

Make Priority Call with Login to SIP

Depending on how your system administrator configures your phone system, your phone might support making and receiving secure calls using the Assured Services for SIP Lines (AS-SIP) feature.

With this feature, routine calls are placed normally. However, during an emergency you can select a priority level that helps ensure the delivery of critical calls. Depending upon how your telephone is configured, you may be required to enter your login information also.

When you receive a priority call, a precedence level icon displays next to the caller's name on your phone display.

For more information, contact your system administrator.

Procedure

- Step 1** Retrieve the handset from the cradle
 - Step 2** Press the **PrecLevel** softkey.
 - Step 3** Select a priority level for the call.
 - Step 4** Enter your credentials on the authorization screen. You have three opportunities to enter your login information correctly.
 - Step 5** Enter the destination number.
You hear the precedence ring back tone and the precedence level icon displays on the screen.
-

Make Priority Call Without Login to SIP

Depending on how your system administrator configures your phone system, your phone might support making and receiving secure calls using the Assured Services for SIP Lines (AS-SIP) feature. You may be required to enter login information.

For more information, contact your system administrator.

To place a priority call without logging in, follow these steps:

Procedure

- Step 1** Retrieve the handset from the cradle.
 - Step 2** Press **PrecLevel**.
 - Step 3** Selects the desired priority level for the call.
 - Step 4** Enter the destination number.
You hear the precedence ringback tone and the precedence level icon displays on the screen.
-

Navigate and Select Items

Task	Action	Example
Scroll to highlight an item.	Press the Navigation pad.	Highlight a call from the missed call list.
Select an item by number.	Press the corresponding number on the keypad.	Press 2 to select the second item in the Applications menu.
Select an item using the Select button.	Press Select at the center of the Navigation pad.	Highlight the Preferences application and press Select.
Navigate to a submenu. A right arrow (>) next to the menu item indicates that a submenu exists.	Highlight the menu item and press the item number on the keypad. Or press the down arrow on the Navigation pad and then press the Select button.	Highlight the Network Setup menu, then press 1 to open the submenu.
Select a line to use a calling feature (when the line is idle).	Press the line button. Indicators of your line selection include: <ul style="list-style-type: none"> • The selected line is displayed on the phone screen header. • Color of the icon (on the line label) changes to blue. 	Press the line button and then press Forward All to forward calls on that line.
Select a line to use a calling feature (when the line has one or more active calls).	Press the line button. Indicators of your line selection include: <ul style="list-style-type: none"> • The selected line is displayed on the phone screen header. • Color of the icon (on the line label) changes to blue. 	Press the line button twice and then press Forward All to forward calls on that line.

View All Calls on Phone



All Calls allows you to view a list, sorted in chronological order (oldest first), of all active calls on all of your phone lines. You see the normal phone calls as well as shared line, barged calls, and conference calls.

You use this feature if you have multiple lines or if you share lines with other users. With the All Calls view:

- All active calls display on one place, making it easy to view and interact with calls on any line.
- When you lift the handset, the phone selects your primary line, which helps prevent inadvertent use of a shared line for dialing.

- You can press the flashing amber session button to answer a ringing call on any line. You do not need to first select the line with the ringing call before answering it.

Your system administrator sets up the All Calls button depending on your call-handling needs and work environment.

The All Calls button is the session key with an associated icon . When the icon changes to , you have missed a call. Press the (icon) to view the call history information for the missed call.

Your system administrator can also set up your primary line to automatically display all calls. Your system administrator can also set up your phone so that after a call completes, the primary line with the All Calls view displays.

Procedure

-
- Step 1** To view all calls, press **All Calls**.
- Step 2** If you do not see the All Calls button, press your primary line key.
-

Answer Calls

Your Cisco IP Phone works just like a regular phone. But we make it easier for you to answer calls.

Answer the Oldest Call First

You can answer the oldest call available on all your phone lines, including Hold Reversion and Park Reversion calls that are in an alerting state. Incoming calls always have priority over Held or Park Reversion calls.

When working with multiple lines, you typically press the line button for the incoming call you want to answer. If you just want to answer the oldest call regardless of line, press **Answer**.

Call Pickup

Call Pickup allows you to answer a call that is ringing on a coworker's phone by redirecting the call to your phone. Your system administrator sets up call groups and can assign you to one or more call groups. Your system administrator also sets up the Call Pickup softkeys depending on your call-handling needs and work environment.

You might use Call Pickup if you share call-handling tasks with coworkers.

There are three ways you can pick up a call:

Pickup

Allows you to answer a call that is ringing on another phone within your call pickup group.

If multiple calls are available for pick up, your phone picks up the oldest call first (the call that has been ringing for the longest time).

Group Pickup

- Allows you to answer a call on a phone that is outside your call pickup group by:
 - Using a group pickup number (provided by your system administrator).
 - Dialing the number of the ringing phone.

Other Pickup

- Allows you to answer a call that is ringing on another phone within in your call pickup group or in an associated call pickup group.

You can also monitor and pick up ringing calls using Line Status indicators if your system administrator has set up Line Status indicators on speed-dial buttons for you. Line Status indicators allow you to see if a line associated with a speed-dial button is idle, in-use, in a Do Not Disturb state, or ringing.

Related Topics

[Line Status Indicators](#), on page 84

Answer a Call Within Your Group (Pickup)

You can answer a call that rings on another phone within your call pickup group. If multiple calls are available for pickup, you'll answer the call that has been ringing for the longest time.

Procedure

- Step 1** (Optional) Press the line button.
 - Step 2** Press **PickUp** to transfer an incoming call within your pickup group to your phone.
 - Step 3** Press **Answer** to connect to the call when the call rings.
-

Answer a Call Using Group PickUp and a Phone Number

Group PickUp allows you to answer a call on a phone that is outside your call pickup group

Procedure

- Step 1** Press **Group PickUp**.
 - Step 2** Enter the number of the phone line with the call that you want to pick up.
For example, if the call is ringing on line 12345, enter 12345.
 - Step 3** Press **Answer** to connect to the call when the call rings.
-

Answer a Call Using Group PickUp and a Group PickUp Number

Procedure

- Step 1** Press **Group PickUp**.
 - Step 2** Enter the group pickup number.
 - Step 3** Press **Answer** to connect the call when the call rings.
-

Answer a Call From an Associated Group (Other Pickup)

Procedure

- Step 1** (Optional) Press the line button.
 - Step 2** Press **PickUp** to answer a call in your pickup group or in a group that is associated with your phone.
 - Step 3** If the call rings, press **Answer** to connect to the call when the call rings.
-

Answer Calls Automatically

If your phone is set up to answer calls automatically, you don't do anything when your phone rings. After one ring, you're automatically connected to the call using the speakerphone.

If you prefer to use your headset to answer the call, set up your headset first.

If you automatically answer calls on your speakerphone and you change the call to the headset, your next incoming call automatically answers on the headset. If you automatically answer calls on your headset and you change the call to the speakerphone, your next incoming call automatically rings on the speakerphone. Automatic answer ensures that the call is answered; it does not change the location you used for the previous call.

Procedure

- Step 1** Connect your headset to your phone.
 - Step 2** Make sure that the **Headset** button  lights up.
 - Step 3** When your phone automatically answers the incoming call, talk to the caller using your headset. If you don't want to use your headset anymore, press the **Headset** button to turn it off, and use the handset or speakerphone instead.
-

Answer Call Waiting

Call Waiting provides the following to notify you that a new call is ringing on your phone when you are talking on another call:

- Call Waiting tone (single beep)
- An amber flashing line button

This feature is configured by the administrator.

Procedure

-
- Step 1** To answer the ringing call, press the flashing amber session button or press **Answer** to answer the call. You can also scroll to the call and press **Select** to answer it. Your phone puts the original call on hold automatically and connects the ringing call.
 - Step 2** If the call is on a different line, you must first press the line button or **All Calls**, if available, to display the ringing session and then answer the call.
 - Step 3** If the call is on the same line and not visible, as there are many calls, then you must scroll to display the sessions.
 - Step 4** If a programmable feature button is set up by your system administrator to answer calls, you can press the feature button to answer a ringing call, regardless of the line of the call or the line that is currently visible. The phone automatically switches the line to display the call.
-

Manage Calls

Divert a Call

You can send an active or ringing call to your voicemail system or to a predetermined phone number.

You can silence the incoming (ringing) call. Press **Volume** down once, and then let the incoming call go to the target number (voicemail or predetermined number set up by the administrator).

Procedure

Decline a call by performing one of the following actions:

- To redirect an incoming (ringing) call while on another call, highlight the incoming call, and then press **Divert**. Otherwise, press **Divert** to redirect the current, active call.
- To redirect an incoming call when you are not on a call, press **Divert**.
- To redirect a held call, press **Divert**.

Transfer Call to Another Number

Transfer allows you to redirect a connected call from your phone to another number:

- You can redirect a single call to another number that you specify.
- You can also connect two calls on one line or two different lines to each other (without remaining on the line yourself).

Before completing a transfer procedure, you can press **Release** or **Cancel** to cancel the transfer or you can press **Swap** to toggle between calls, which allows you to speak privately with each party.

Procedure

Step 1 Start with an active call (not on hold).

Step 2 Press **Transfer**  and do one of the following to enter the transfer recipient's phone number:

- Press the pulsing green session button of a held call (right side).
- Enter the transfer recipient's phone number.
- Scroll to a Call History record and press **Call**.
- Press a speed-dial button.
- Press **Speed Dial**, enter a speed-dial number or highlight the number you want to call, and press **Speed Dial** again.
- Press **Active Calls** and select a held call. The transfer completes immediately.
- If the Simplified New Call window is enabled, press **Directory** to select a contact from the phone directory.

Note When the Simplified New Call window is disabled, you cannot search the directory to find a number to receive the transferred call.

Step 3 Press **Transfer** or **Trnsfer**.

You need to hear the ring tone before you press **Transfer**. You do not need to wait for the recipient to answer to complete the transfer.

Consult Before You Complete a Transfer

Before you transfer a call, you can talk to the person that you're transferring the call to. You can also swap between that call and the call that you're transferring, before you complete the transfer.

Before You Begin

You have an active call that needs to be transferred.

Procedure

- Step 1** Press **Transfer** .
- Step 2** Enter the other person's phone number.
- Step 3** Press **Swap** to return to the held call.
- Step 4** Press **Transfer** to complete the transfer.
-

Record a Call

You can record a call. You might hear a notification tone as you record the call.

Procedure

Press **Record** to start or stop recording.

Call Forward

You can forward calls from any line on your phone to another number. Call forward is phone-line specific. If a call reaches you on a line where call forwarding is not enabled, the call rings as usual.

There are two types of call-forwarding features that your administrator can set up on your phone:

- Unconditional call forwarding (call forward all) — Applies to all calls that you receive. You can set up call forward all directly on your phone for any line. To set up call forward all remotely, go to the Self Care Portal.
- Conditional call forwarding (call forward no answer, call forward busy, call forward no coverage) — Applies to certain calls that you receive. To set up conditional call forwarding remotely, go to the Self Care Portal.

Forward Calls

Procedure

Enter the call forward target number exactly as you would dial it from your phone, or select an entry from your list of recent calls.

Mute Phone

You can block audio input for your handset, headset, and speakerphone, so that you can hear other parties on the call but they cannot hear you.

When the Separate Audio and Video Mute feature is enabled, you mute the audio but continue to send a video image when you press Mute during a video call. This allows the other parties to see you but not to hear you. When this feature is disabled, you mute both the audio and the video image when you press Mute during a video call.

The Separate Audio and Video Mute feature is disabled by default. See your administrator to have it enabled.

Procedure



- Step 1** Press **Mute**  to turn Mute on.
- Step 2** Press **Mute** again to turn Mute off.
-

Hold Call

Hold allows you to put an active call into a held state. Your phone allows one active call at a time; other calls are put on hold.

Hold works with your phone handset as well as with USB headsets.

Procedure

- Step 1** To put a call on hold, press the **Hold**  hardkey.
- The Hold icon  displays and the line button pulses green.
- Step 2** To resume the highlighted call, do one of these:
- Press **Hold** again.
 - Press the pulsing green session button.
 - Press the call session on the phone display (applicable for Cisco Unified IP Phone 9971 only).
 - Press **Resume**.
 - Press Select in the Navigation pad.
-

Swap Between Active and Held Calls

Use the session buttons to swap between holding and connected calls.

Procedure

If you have a held call and an active call, press **Session** for the held call to resume that call and place the other call on hold automatically.

Put Call on Hold by Answering New Call

If you are already on a call and receive a new call, answering the new call puts the first call on hold automatically.

Answer the new call with one of the following methods:

Procedure

- Step 1** Press the flashing amber **Session** button or press **Session** on the touchscreen (applicable for Cisco Unified IP Phone 9971 only).
- Step 2** Navigate to the new call using the **Navigation** pad and either press **Answer** or **Select**.
-

Answer a Call Left on Hold for Too Long

When you've left a call on hold too long, you'll be notified with these cues:

Procedure

Determine If a Shared Line Is On Hold

If a call on a shared line is placed on hold, a pulsing red line button and the hold  icon display on the phone screen.

Remote Hold

When you place a call on hold while using a shared line, the line button pulses green and your phone displays the **Hold**  icon. When another phone places a call on hold, the line button pulses red and your phone displays the **Remote Hold** icon.

Get Notified When a Contact is Available

If you call someone and their line is busy or they do not answer, you can be notified with a special ringtone and a message when they are available.

Procedure

- Step 1** Press **Callback** while you are listening to the busy tone or ring sound.
- Step 2** Press **Exit** to exit the confirmation screen.
- Step 3** When you hear the ringtone that the person is available and see the message, press **Dial** to place the call again.
-

Call Park

You can use your phone to park (temporarily store) a call. You can then retrieve the call from another phone (such as a phone at a coworker's desk or in a conference room).

There are two ways you can park a call:

Park

Allows you to park an active call that you answered on your phone. You can then use another phone in the Cisco Unified Communications Manager system to retrieve the call.

Directed call park

Allows you to park and retrieve an active call in two different ways:

- Assisted directed call park—You use a feature button to park an active call; your administrator sets up the button as a speed-dial line.

With this type of directed call, you can use line status indicators to monitor the status of the line (in-use or idle).

- Manual directed call park—You park an active call by transferring it to a directed call number, which your administrator sets up.

To retrieve the call at another phone, you dial a park retrieval prefix number. You then dial the directed call number that you used to park the call.

Your administrator sets up either the directed call park or the park feature on your phone, but not both.

Related Topics

[Line Status](#), on page 84

Park and Retrieve a Call Using Call Park

Procedure

- Step 1** During a call, press **Park**, and then hang up.

Your phone displays the number where the system parked the call. The parked call is put on hold, and you can press **Resume** to resume the call on your phone.

Step 2 From any other Cisco IP Phone in your network, enter the number where the call is parked to retrieve the call.

Step 3 If you do not retrieve the call within a certain amount of time (set by your system administrator) you receive an alert tone, at which time you can:

- Press **Answer** to answer the call on your phone.
- Retrieve the call from another phone.

If you fail to retrieve or answer the call within a specified amount of time, the call is redirected to another destination (set up by your system administrator), such as voicemail. If the call gets redirected, it can no longer be retrieved by using Call Park.

Place a Call on Hold with Assisted Directed Call Park

Procedure

Step 1 On a call, press **BLF Directed Call Park** on a line that displays an idle line status indicator.

Step 2 Retrieve the call from any other phone in your network:

- a) Enter the park retrieval prefix.
- b) Dial the directed call number.

Step 3 If you do not retrieve the call within the time that your administrator has set, you receive an incoming call with notification of CallPark Reversion. You can then press **Answer** to answer the call. The other phones can no longer retrieve that call.

- Press **Resume** to resume the call on your phone.
 - Retrieve the call from another phone.
-

Place a Call on Hold with Manual Directed Call Park

Procedure

Step 1 During a call, press **Transfer** .

Step 2 Enter the directed call number where you will park the call.

Step 3 Press **Transfer** again to finish parking the call and then hang up.

Step 4 Retrieve the call from any other phone in your network as follows:

- a) Enter the park retrieval prefix.

b) Dial the directed call number.

Step 5 If you do not retrieve the call within the time that your administrator has set, you receive an alert tone. You can then do one of the following:

- Press **Resume** to resume the call on your phone.
 - Retrieve the call from another phone.
-

Intercom Calls

You can use an intercom line to place and receive one-way calls.

When you place an intercom call, the recipient's phone answers the call automatically with mute activated (whisper mode). Your message is broadcast through the recipient's speakerphone, headset, or handset, if one of these devices is active.

After receiving the intercom call, the recipient can start two-way audio (connected mode) to allow for further conversation.

Place a Dedicated Intercom Call

Procedure

- Step 1** Press **Intercom**.
Your phone enters whisper mode until the recipient accepts the intercom call. If you are on an active call, that call is placed on hold.
- Step 2** Listen for the intercom alert tone, and then begin speaking.
- Step 3** Press **Intercom** to end the call.
-

Place a Dialable Intercom Call

Procedure

- Step 1** Press **Intercom**.
- Step 2** Enter the intercom code.
Your phone enters whisper mode until the recipient accepts the intercom call. If you are on an active call, that call is placed on hold.

Step 3 Listen for the intercom alert tone, and then begin speaking.

Step 4 Press **Intercom** to end the call.

Answer an Intercom Call

You can answer an intercom call to talk to the other person.

Before You Begin

You receive a message on your phone screen, and an audible alert. Your phone answers the intercom call in whisper mode.

Procedure

Step 1 Press **Intercom** to switch to connected mode. In connected mode, you can speak to the intercom caller.

Step 2 Press **Intercom** to end the call.

Video Calls

The Cisco Unified IP Phones supports phone calls that contain video (if present). With these phones, you do not need to install the Cisco Unified Video camera to receive the video portion of a call.



Note The Cisco Unified IP Phone 8961 does not support video.

Toggle Between Phone and Video Display

If you need to see your phone's desktop while you're on a video call, you can easily switch between the video and the desktop. When you hide the video, it blurs and moves to the background.

Procedure

Step 1 Press **Hide video** to hide the video.

Step 2 Press **Show video** to show the video.

Hide Softkeys in Full-Screen Video

The softkeys display on the screen when a full-screen video call is enabled. If there is no user activity, the softkeys automatically hide after 10 seconds.

Procedure

To display the softkeys, do one of the following actions:

- Press **Mute**.
- Change the state of the video such as by plugging in the camera.
- Touch the phone screen (Cisco Unified IP Phone 9971 only).
- Press any softkey (Cisco Unified IP Phone 9951 only).

Enable Full Screen Video

Procedure

-
- Step 1** Press **Full Screen**.
- Step 2** Press **Minimize** to return to the original view.
-

Mute Video

Mute allows you to block audio input for your handset, headset, and speakerphone, so that you can hear other parties on the call but they cannot hear you.

When the Separate Audio and Video Mute feature is enabled, you mute the audio but continue to transmit a video image when you press Mute during a video call. This allows the other parties to see you but not to hear you. When this feature is disabled, you mute both the audio and the video image when you press Mute during a video call.

The Separate Audio and Video Mute feature is disabled by default. See your administrator to have it enabled.

Procedure

-
- Step 1** Press **Mute Video**.
- Step 2** Press **Unmute Video** to unmute the video.
-

Swap Views

Procedure

Press **Swap** to toggle between the full-screen view and the picture-in-picture (PIP) view. The **Swap** is only available if you are in full-screen view.

Adjust the Picture-In-Picture Position

When you are on a video call, you can view your incoming and your outgoing video at the same time, which is known as Picture-in-Picture (PiP). Typically, the incoming video displays on the full screen and a small inset screen shows the video from your camera.

When PiP is on, you can move the inset picture to a different quadrant of the screen. You can also change the view so that your camera video displays on the full screen and the inset displays the incoming video.

Procedure

-
- Step 1** Press **PiP** to turn on PiP.
- Step 2** Press **PiP** again to move the PiP window counter-clockwise around your phone screen. When the window returns to the default lower right position, PiP automatically turns off.
- Step 3** (Optional) Press **Swap** to toggle between the full-screen view and the PiP view.
-

View Phone Information

The Phone Information window displays the following information about your phone:

- Host Name
- IP Address (some phones display IPv4 Address and IPv6 Address)
- MAC Address
- Active Load
- Last Upgrade
- Active Server
- Stand-by Server

Procedure

- Step 1** Press **Applications** .
 - Step 2** Use the Navigation pad and Select button to scroll and select **Phone Information**.
 - Step 3** Press **Exit** softkey to return to the Applications screen.
-

Sign In to the Cisco Unified Communications Self Care Portal

Your phone is a network device that can share information with other network devices in your company, including your personal computer. You can use your computer to sign in to the Cisco Unified Communications Self Care Portal, where you can control features, settings, and services for your phone. For example, you can manage your phone display language, set up services, add entries to your personal address book, and set up speed-dial codes.

Before you can access any of your options, such as speed dial or personal address book, you must sign in. When you finish using the portal, sign out.



Note Some features may not be available for your phone, and thus you can't set the features up in the Self Care Portal.

Sometimes, you can access the Cisco Unified Communications Self Care Portal without signing in.

For assistance in using the portal, see the *Cisco Unified Communications Self Care Portal User Guide* at http://www.cisco.com/en/US/products/sw/voicesw/ps556/products_user_guide_list.html.

Procedure

- Step 1** Obtain the portal URL, user ID, and default password from your administrator. Typically, the portal URL is `http://ip_address` or `hostname/ucmuser`.
 - Step 2** Open a web browser on your computer and enter the URL.
 - Step 3** If prompted to accept security settings, select **Yes** or **Install Certificate**.
 - Step 4** Enter your user ID in the **Username** field.
 - Step 5** Enter your password in the **Password** field.
 - Step 6** Select **Login**.
 - Step 7** Select **Logout** to sign out.
-



Contacts

- [Corporate Directory](#), page 57
- [Personal Directory](#), page 58
- [Fast Dial](#), page 61
- [Fast-Dial Codes with Personal Directory](#), page 61
- [Cisco Web Dialer](#), page 63



Corporate Directory

You can look up a coworker's number from your phone, which makes it easier to give them a call. Your administrator sets up and maintains the directory.

Search and Dial Contact

Procedure

- Step 1** Press **Contacts** .
- Step 2** Use the Navigation pad and Select button to scroll and select **Corporate Directory**.
- Step 3** Select one or all of these search criteria to search for a coworker:
- First Name
 - Last Name
- Step 4** Enter the search criteria information, press **Submit**, and select a contact.
- Step 5** To dial, perform one of these actions:
- Press **Dial**.
 - Press **Select**.
 - From the keypad, press the number that displays in the upper right corner of the contact label.

- Press **Speakerphone** .
 - Press **Headset** .
 - Pick up the handset.
-

Search and Dial Contact While on Call

Procedure

- Step 1** Press **Contacts** .
- Step 2** Use the Navigation pad and Select button to scroll and select **Corporate Directory**.
- Step 3** Select one or both of these search criteria to search for a coworker:
- First Name
 - Last Name
- Step 4** Enter the search criteria information and press **Search** .
- Step 5** Press **Dial**.
The phone puts the existing call on hold and makes the new call.
-

Personal Directory

Use the personal directory to store the contact information for friends, family, or coworkers. You can add your own contacts to the personal directory. You can add special speed-dial codes for people who you often call.

You can set up your personal directory from your phone or from the Self Care portal. Use your phone to assign speed-dial codes to the directory entries.

Sign In and Out of a Personal Directory

Before You Begin

Before you can sign in to your personal directory, you need your user ID and PIN. Contact your administrator if you don't know this information.

Procedure

- Step 1** Press **Contacts** .
 - Step 2** Select **Personal directory**.
 - Step 3** Enter your user ID and PIN, and press **Submit**.
 - Step 4** To sign out, select **Log out**, press **Select**, and then press **OK**.
-

Add Personal Directory Entry from Phone

Procedure

- Step 1** Press **Contacts** .
 - Step 2** Sign in to Personal Directory.
 - Step 3** Select **Personal Address Book**.
The Search for an entry screen displays.
 - Step 4** Press **Submit**.
 - Step 5** Press **New**. You may need to press **More** first.
 - Step 6** Enter the nickname information.
You can also enter a name.
 - Step 7** Press **Phones** and enter the phone numbers.
Make sure you include any required access codes, such as 9 or 1.
 - Step 8** Press **Submit** to add the entry to your personal directory.
-



Search for a Contact in Your Personal Directory

Procedure

- Step 1** Press **Contacts** .
 - Step 2** Sign in to your personal directory.
 - Step 3** Select **Personal Address Book**.
 - Step 4** Select a search criteria.
 - Step 5** Enter your search criteria and press **Submit**.
-

Dial a Number from Your Personal Directory

Procedure

- Step 1** Press **Contacts** .
- Step 2** Sign in to your personal directory.
- Step 3** Select your **Personal Directory**.
- Step 4** Press **Submit** to search for an entry.
- Step 5** Select the entry that you want to dial.
- Step 6** Perform one of the following actions:
- Press **Dial**.
 - Press a line button.
 - Press **Speakerphone** .
 - Press **Headset**.
 - Pick up the handset.
-

Edit Personal Directory Entry

Procedure

- Step 1** Press **Contacts** .
- Step 2** Sign in to Personal Directory.
- Step 3** Select **Personal Address Book** and search for an entry.
- Step 4** Press **Select**.
- Step 5** Press **Edit**.
- Step 6** Modify the entry information.
- Step 7** Press **Phones** to modify a phone number.
- Step 8** Press **Update**.
-

Delete Personal Directory Entry

Procedure

- Step 1** Press **Contacts** .
- Step 2** Sign in to Personal Directory.
- Step 3** Select **Personal Address Book** and search for an entry.
- Step 4** Press **Select**.
- Step 5** Press **Edit**.
- Step 6** Press **Delete**.
You may need to press **More** first.
- Step 7** Press **OK** to confirm the deletion.
-

Fast Dial

Fast Dial allows you dial a phone number from the Fast Dial service on your phone.

Place Call with Fast Dial Button

Procedure

- Step 1** Press **Fast Dial**.
- Step 2** Sign in to Personal Directory.
- Step 3** Select **Personal Fast Dials**.
- Step 4** Perform one of the following actions:
- Use the keypad to enter the fast-dial code.
 - Scroll to and select a fast-dial code and then press the **Dial** softkey.
-

Fast-Dial Codes with Personal Directory

You can use the **Contacts** menu on your phone to manage the fast-dial codes in your personal directory.

Assign Fast-Dial Code to Personal Directory Entry

Procedure

- Step 1** Press **Contacts** .
 - Step 2** Use the Navigation pad and Select button to scroll and select **Personal Directory**.
 - Step 3** Select **Personal Address Book**.
 - Step 4** Enter the name information and press **Submit**.
 - Step 5** Press **Select** and then press **FastDial**.
 - Step 6** Select a number and press **Select**.
 - Step 7** Scroll to an unassigned fast-dial index. You may have to press **Next** to get to more fast-dial indexes.
 - Step 8** Press **Select**.
-

Call a Contact with a Fast-Dial Code

Procedure

- Step 1** Press **Contacts** .
 - Step 2** Sign in to your personal directory.
 - Step 3** Select **Personal Fast Dials** and scroll to a fast-dial code.
 - Step 4** Select the required fast-dial code and press **Dial**.
-

Delete a Fast-Dial Code

Procedure

- Step 1** Press **Contacts** .
 - Step 2** Sign in to your personal directory.
 - Step 3** Select **Personal Fast Dials** and search for a fast-dial code.
 - Step 4** Select the required code and press **Remove**.
 - Step 5** Select the index and press **Remove**.
-

Cisco Web Dialer

You can use Cisco Web Dialer, a web browser, and your Cisco IP phone to make calls from web and desktop applications. Use your web browser and go to a website or your company directory, and then click a hyperlinked phone number to begin your call.

You need a user ID and password to make a call. Your administrator can give you this information. First-time users have to configure their preferences before a call.

For more information, see the “Cisco Web Dialer” document in <https://www.cisco.com/c/en/us/support/unified-communications/unified-communications-manager-callmanager/products-installation-and-configuration-guides-list.html>

Use Cisco Web Dialer with Another Online Corporate Directory

Procedure

- Step 1** (Optional) If you have more than one phone of the same type configured, identify the MAC address of the phone to be used:
- Press **Applications**
 - Select **Phone Information**
 - Write down the MAC address of the phone.
- Step 2** In a web browser, type the address of the Cisco WebDialer-enabled page:
[https://\[CUCM IP address\]/webdialer/Webdialer](https://[CUCM IP address]/webdialer/Webdialer)
- Step 3** Enter your user ID and password.
- Step 4** (Optional) If you are using Cisco Web Dialer for the first time, review preferences on the **Make Call** window.
- Step 5** Choose a line or a phone.
If you have one phone with a single line, the appropriate phone and line are automatically selected.
If you have more than one phone of the same type, use the MAC address to identify the phone.
- Step 6** Enter the phone number that you want to dial, and press **Dial**.
- Step 7** Press **Hang up** or hang up the handset after you complete your call.
-

Change Cisco Web Dialer Preferences

Procedure

- Step 1** Use Cisco Web Dialer to start a call and access the **Make Call** window.
- Step 2** Select one of the following options from the **Make Call** window:
- **Preferred language**

- Preferred device

Step 3 Choose a line or a phone.

Step 4 If you have an Extension Mobility profile, select **Extension Mobility** from the **Calling Device** drop-down list.

Step 5 Ensure that you don't select **Do not display call information** or **Disable Auto Close**.
If you select **Do not display call information**, the **Make Call** window is not displayed when you next use the phone.

If you select **Disable auto close**, the window does not close automatically after 15 seconds.

Sign Out of Cisco Web Dialer

Procedure

Step 1 Access the **Make Call** or **Hang Up** window.

Step 2 Select **Sign Out**.



Call History

- [Call History Overview, page 65](#)
- [View Call History, page 67](#)
- [View Call Record Details, page 67](#)
- [Filter Call History, page 68](#)
- [Dial from Call History, page 68](#)
- [Edit Number from Call History, page 69](#)
- [Clear Call History, page 69](#)
- [Delete Call Record from Call History, page 69](#)



Call History Overview

Call History allows you to view information about the last 150 calls on your phone. The Call History lists individual calls and call groups chronologically from the most recent call to the oldest one. If your phone has multiple lines, calls on all lines are added together. The oldest calls over the 150-call limit are dropped from the history.

In the Call History screen, the line information (such as “Line: 5623”) displays in the upper right corner to indicate the line name or number for which the call history is displayed.

If set up by your administrator, you see icons beside each Call History entry. The icon shows the status (Unknown, Idle, Busy, or DND) of the person who made the call.

For each call record or call group, an icon to the left of the caller ID shows the call type:

- Received: 
- Placed: 
- Missed: 

If the caller ID is unavailable, “Unknown” is displayed, and the phone number is listed.

Calls for the same caller ID and phone number are grouped together only when if they occur in chronological order and do not have calls associated. For each group, the time of the latest call and the number of calls (such as “(3)”) are displayed:





- Incoming (Received) and outgoing (Placed) calls are grouped together.
- Missed calls are grouped together in a separate group.

For each individual call record or call group, the phone number is listed in blue and is contact sensitive for touch dialing.

Hunt group and multiparty calls show an icon to the right of the caller ID that differentiates the call from a normal call, and these calls are not grouped even when they are next to each other in the list.

A plus (+) symbol on entries in call history, redial, or call directory indicates that your phone is set up to list international calls. For more information, contact your system administrator.

The received and placed calls from shared lines are logged in the Call History. To view all the call history logs, open the Call History screen. The following table describes the call state, icon, and tag for shared lines.

Call State	Call Icon	Tag
Locally placed calls		Placed
Locally received calls		Received
Remotely placed calls		Remote Placed
Remotely received calls		Remote Received
Missed calls		Missed

Your Call History list displays the status of monitored lines, if the feature is enabled by your system administrator. Each call history item in the Call History lists displays an icon to identify the state of the line. The following states are available:



- Unknown
- Idle
- Busy
- DND

If you use Cisco IP Manager Assistant (IPMA), you can request that your administrator set up your phone so that private calls are handled in the Call History in this manner:

- (Default) The log record for the private call displays *Private*.
- The log record for the private call is not saved.



View Call History

Procedure

- Step 1** Perform one of the following actions:
- Press **All Calls** .
 - Press **Applications**  and select **Call History**.
- Step 2** Use the Navigation pad and Select button to scroll and select a call record or call group.
- Step 3** Press **Exit** to return to the Applications screen.
-

View Call Record Details

Procedure

- Step 1** Press **Applications** .
- Step 2** Use the Navigation pad and Select button to scroll and select **Call History**.
- Step 3** Select a call record or group and press **Details**. You may need to press the **More** softkey first. When you are on a call record, you can also press the right arrow on the Navigation pad to display the call details (may be reversed on phones that use a right-to-left mode, such as for Arabic).
- For each individual call, the Details screen displays the line information in the upper right corner, such as “Line: 5782,” and the call name, call number, alternate number (if available), call disposition (call type), call duration, and time of the call.
 - For each call group, the details shown are the same as for an individual call. The only difference is that the multiple call-related information is shown, such as call disposition (call type), call duration, and time of call, because this is a group of calls (Placed/Received or Missed). In a group of Missed calls, individual records show no call duration.
 - For each multiparty or hunt group call, the Details screen displays the line information in the upper right corner. For the caller ID and number listed at the top of the screen, displays the call name, call number, alternate number, and the hunt group information, if available.
- Step 4** Press **Return**  to return to the Call History screen.
- Step 5** Press **Exit** to return to the Applications screen.
- Step 6** While on a connected call, press **Show Details** to show the Call Details screen. This screen displays single call information and call duration and updates each second.
-



Filter Call History

Procedure

- Step 1** Press **Applications** .
- Step 2** Use the Navigation pad and Select button to scroll and select **Call History**.
The default view in Call History is for “All Calls,” which is shown at the top of the screen. The line information, such as “Line: 5623,” is shown in the upper right corner.
- Step 3** To sort calls for a specific phone line, select that phone line and view the individual calls or call groups for that line.
- Step 4** To sort by missed calls for the selected line, press **Missed Calls** softkey.
- Step 5** Press **Exit** to return to the Applications screen.
-



Dial from Call History

Procedure

- Step 1** Press **Applications** .
- Step 2** Use the Navigation pad and Select button to scroll and select **Call History**.
- Step 3** From the Call History screen, select the call record that you want to dial and perform one of the following actions:
- Press **Call**.
 - Pick up the handset.
 - Press **Select**.
 - Press **Speakerphone**  or **Headset** .
- Step 4** When the phone is in idle, you can press the down arrow on the Navigation pad to display the On-Hook Dialing screen.
-

Edit Number from Call History

Procedure

- Step 1** Press **Applications** .
 - Step 2** Use the Navigation pad and Select button to scroll and select **Call History**.
 - Step 3** Highlight the call record that you want to edit.
 - Step 4** Press **EditDial** . You may need to press **More** first.
 - Step 5** Press the right or left arrow on the Navigation pad to move the cursor to the desired location.
 - Step 6** Press  to delete numbers on the left of the cursor.
 - Step 7** Enter numbers using the phone keypad.
 - Step 8** Press **Call** to dial the new edited number.
 - Step 9** Press **Return**  to return the Call History screen.
-

Clear Call History

Procedure

- Step 1** Press **Applications** .
 - Step 2** Use the Navigation pad and Select button to scroll and select **Call History**.
 - Step 3** Press **Clear List** to clear the entire call history on the phone. You may need to press **More** first.
 - Step 4** Confirm the list clearing by pressing **Delete** or press **Cancel**.
 - Step 5** Press **Exit** to return to the Applications screen.
-

Delete Call Record from Call History

Procedure

- Step 1** Press **Applications** .
- Step 2** Use the Navigation pad and Select button to scroll and select **Call History**.
- Step 3** Highlight the individual call record or call group that you want to delete.
- Step 4** To delete an individual call record, press **Delete**. You may need to press **More** first.
- Step 5** To delete a call group, press **Delete** to delete all calls in the group.

A Delete Record alert message appears to verify that you want to delete the entire group of calls.

Step 6 Press **Delete** to delete the record, or press **Cancel** if desired.

Step 7 Press **Exit** to return to the Applications screen.



Voicemail

- [Your Voicemail Account, page 71](#)
- [Access Voicemail, page 71](#)
- [Check for Voice Messages, page 72](#)
- [Listen to Voice Messages, page 72](#)

Your Voicemail Account

The **Messages** button on your phone acts as a speed dial into the voicemail system.

The voicemail system is not part of the phone. The voicemail system is a separate system that the phone and the call server communicate with to give you voicemail capability.

When you aren't at your desk, you can call your voicemail system to access your voicemail. Typically, your voicemail system has a phone number that you can dial directly and then follow the prompts to log into your voice mailbox. Your administrator can give you the voicemail system phone number.

Because each voicemail system is different, we can't tell you how to use your voicemail system. For information and help with your voicemail commands, see the voicemail system user documentation or contact your administrator or IT department.

Access Voicemail





Procedure

- Step 1** Press **Messages** .
- Step 2** Follow the voice prompts.
-

Check for Voice Messages

Procedure

Check for voice messages in any of these ways:





- Look for a solid red light on your handset.
You can set up the visual message waiting lamp using the Self Care Portal.
- Look for a **Message icon**  on a line label.
The red background indicates that there are new voice messages.
When you select a line with a **Message icon**, a **Voicemail icon**  displays on the right side of the phone screen.
Depending on your voicemail system, you might see a count of your new voice messages on the **Message icon**  and **Voicemail icon** .
If there are more than 99 new voice messages, the message count is replaced by a plus (+) sign.
If call forwarding is set up on a line that has new voice messages, the **Call Forward icon**  replaces the **Message icon** on the line label.
- Listen for a stutter tone (if available) from your handset, headset, or speakerphone when you place a call.
The stutter tone is line-specific. You hear it only when using the line that has new voice messages.
You can set up audible message waiting tones using the Self Care Portal.

Listen to Voice Messages

After you listen to your new voice messages, the message indicators are updated on the phone screen. If there are no new voice messages, the Message icon is removed from the line label, and the Voicemail icon is removed from the right side of the phone screen.

Procedure

Step 1 To listen to voice messages, do one of the following:

- Press **Messages** .
- Select a line with a **Message icon** .
- Press **Session**  next to the **Voicemail icon** .
- On a Cisco Unified IP Phone 9971 touchscreen, press **Voicemail** .

Step 2 Follow the prompts to listen to your voice messages.



Advanced Calling Features

- [Conference Calls and Meetings, page 75](#)
- [Scheduled Conference Calls \(Meet Me\), page 77](#)
- [Speed Dial, page 78](#)
- [Do Not Disturb, page 80](#)
- [Malicious Call Identification, page 81](#)
- [Extension Mobility, page 81](#)
- [Phone Calls with Mobile Connect, page 82](#)
- [Line Status, page 84](#)
- [Custom Line Filters, page 85](#)
- [Hunt Groups, page 88](#)
- [Barge , page 89](#)
- [Call Chaperone, page 91](#)
- [Uniform Resource Identifier Dialing, page 92](#)

Conference Calls and Meetings

You can talk with several people in a single call. You can dial another person and add them to the call. If you have multiple phone lines, you can join two calls across two lines.

When you add more than one person to a conference call, wait a few seconds between adding participants.

As the conference host, you can remove individual participants from the conference. The conference ends when all participants hang up.

Add Third Party to Conference

Procedure

- Step 1** Start with a connected call that is not on hold.
- Step 2** Press **Conference**  and do one of the following:
- Enter the phone number for the party you want to add and press **Call**.
 - Press a speed-dial button.
 - Press **Speed Dial**, enter a speed-dial number and press **Speed Dial** again.
 - Press **Active Calls** and select a call.
 - Select a call from the Call History.
- Step 3** Wait for the party to answer (or skip to step 4 while the call is ringing).
- Step 4** Press **Conference**.
The conference begins.
-

Join Calls into Conference

The conference is established on the line that had the active call.

Procedure

- Step 1** Start with two connected calls.
- Step 2** Make sure that one of the calls is active (not on hold). If both calls are on hold, resume one call.
- Step 3** Press **Conference** .
- Step 4** Press the line button for the other (held) call or if the held call is on another line:
- a) Press **Active Calls**.
 - b) Choose a call from the list.
 - c) Press **Conference**.
- The conference begins. The conference is established on the line that had the active call.
-

Swap Between Calls Before You Complete a Conference

You can talk to a person before you add them to a conference. You can also swap between the conference call and the call with the other person.

Procedure

- Step 1** Call a new conference participant, but do not add the participant to the conference. Wait until the call is connected.
 - Step 2** Press **Swap** to toggle between the participant and the conference.
-

View and Remove Conference Participants

If you create a conference, you can view the details of the last 16 participants who join the conference. You can also remove participants.

Procedure

- Step 1** While you are in a conference, press **Show Details** to view a list of participants.
 - Step 2** (Optional) Highlight a participant and press **Remove** to drop the participant from the conference.
-

Remove Conference Participants

Procedure

- Step 1** While in a conference, press **Show Details**.
 - Step 2** Highlight the participant that you want to remove, then press **Remove**.
-

Scheduled Conference Calls (Meet Me)

You can host or join a conference call at a scheduled time.

The conference call does not start until the host dials in, and it ends when all participants hang up. The conference does not automatically end when the host hangs up.

Host a Meet-Me Conference

Before You Begin

Get a meet-me phone number from your administrator, and distribute the number to the conference participants.

Procedure

- Step 1** Lift the handset to get a dial tone and press **Meet Me**.
- Step 2** Dial the meet-me phone number.
-

Join a Meet-Me Conference

You cannot join a meet-me conference until the conference hosts dials in. If you hear a busy tone, the host has not dialed into the conference. Hang up and try your call again.

Procedure

Dial the meet-me phone number that the conference host provides.

Speed Dial

You can assign buttons or codes to quickly dial the numbers of people you call often. Before you can use speed-dial features on your phone, set up speed dial in the Self Care portal.

Depending on your setup, your phone can support these features:

- Speed-dial buttons—Dial a phone number from one or more line buttons set up for speed dialing.
- Speed-dial codes—Dial a phone number from a code (sometimes referred to as abbreviated dialing).

Make a Call with a Speed-Dial Button

To check which phone model you have, press **Applications**  and select **Phone information**. The **Model number** field shows your phone model.

When you add features to your phone, some features require a line button. But each line button on your phone can support only one function (a line, a speed dial, or a feature). If your phone's line buttons are already in use, your phone won't display any additional features.

You can see all the speed-dial numbers that you add in the Self Care portal. Use the up and down buttons in the navigation cluster to scroll through your speed-dial numbers, then select a speed-dial number.

Before You Begin

Set up speed-dial codes in the Self Care portal.

Procedure

Press a speed-dial button .

Use Speed-Dial Code On-Hook

Before You Begin

Before you can use speed-dial codes on your phone, you must set up Speed Dial in the Self Care Portal.

Procedure

Enter the speed-dial code and press **Speed Dial**.

Use Speed-Dial Code Off-Hook

Before You Begin

Before you can use speed-dial codes on your phone, you must set up Speed Dial in the Self Care Portal.

Procedure

-
- Step 1** Lift the handset and press **Speed Dial**.
- Step 2** Enter the speed-dial code and press **Speed Dial** again to complete the call.
-

Pauses in Speed Dial

You can add dialing pauses, or extra digits to a speed dial. When you press the speed dial, your phone establishes the call and sends the extra digits with dialing pauses inserted. Extra digits can include:

- A Forced Authorization Code (FAC)
- A Client Matter Code (CMC)
- A user extension
- A meeting access code
- A voicemail password

To include dialing pauses in the speed dial, include a comma (,) as part of the speed-dial string. Each comma that you include represents an extra pause of 2 seconds. For example, two commas (,,) represent a pause of 4 seconds. A single comma also allows you to separate FAC and CMC from the other digits in the speed-dial string.

Be aware of the following requirements when you include FAC and CMC in the speed-dial string:

- FAC must always precede CMC in the speed-dial string.
- A speed-dial label is required for speed dials with FAC and DTMF digits.
- Only one comma is allowed between FAC and CMC digits in the string.

Your phone does not save the FAC, CMC, or extra digits from the speed dial in the call history. If you press **Redial** after connecting to a destination using speed dial, the phone prompts you to enter any required FAC, CMC, or DTMF digits manually.



Tip

Before you configure speed dial, try to dial the specified digits manually at least once to ensure that the digit sequence is correct.

Example 1

Consider the following requirements to access your voicemail and playback the most recent message:

- The number to access voicemail is 8000.
- The PIN is 123456#.
- You must wait for 6 seconds while the voicemail system prompts you.
- You must press 3 to play latest message.

In this scenario, the speed dial number is 8000,123456#,,3.

Example 2

Consider the following call requirements:

- The called number is 95556543.
- The FAC is 1234.
- The CMC is 9876.
- You must wait for 4 seconds.
- After the call is connected, you must add 56789#.

In this scenario, the speed dial number is 95556543,1234,9876,,56789#.

Do Not Disturb

You can turn off one of the following incoming call indicators:

- Your phone ring
- Your phone ring and any visual notification that you have an incoming call

When you enable the do not disturb (DND) feature, your incoming calls forward to another number, such as your voicemail, if it is set up. The call is not saved or listed in your call history.

The DND feature affects all lines on a phone. The feature does not affect intercom or emergency calls.

You can change your DND options from the Self Care Portal. For information on customizing your DND options, see the *Cisco Unified Communications Self Care Portal User Guide* at http://www.cisco.com/en/US/products/sw/voicesw/ps556/products_user_guide_list.html.

Turn On Do Not Disturb

Use do not disturb (DND) to silence your phone and ignore incoming call notifications when you need to avoid distractions.

When you turn on DND, your incoming calls are forwarded to another number, such as your voicemail, if it is set up.

When you turn on DND, it affects all lines on your phone. However, you will always receive intercom and emergency calls, even when DND is turned on.

Procedure

- Step 1** Press **Do not disturb** to turn on DND.
 - Step 2** Press **Do not disturb** again to turn off DND.
-

Malicious Call Identification

You can use malicious call identification (MCID) to identify an active call as suspicious. MCID starts a series of automated tracking and notification messages.

Trace a Suspicious Call

If you receive unwanted or harassing calls, use malicious call identification (MCID) to alert your administrator. Your phone sends a silent notification message to your administrator with information about the call.

Procedure

Press **MCID**.

Extension Mobility

Cisco Extension Mobility (EM) allows you to configure a Cisco Unified IP Phone as your own temporarily. After you sign in to EM, the phone adopts your user profile, including your phone lines, features, established services, and web-based settings. Your system administrator sets up EM for you.

The Cisco Extension Mobility ChangePIN feature allows you to change your PIN from your Cisco Unified IP Phone.

Sign In to Your Extension from Another Phone

You can use Cisco Extension Mobility to sign in to a different phone in your network and have it act the same as your phone. After you sign in, the phone adopts your user profile, including your phone lines, features,

established services, and web-based settings. Your administrator sets you up for the Cisco Extension Mobility service.

Before You Begin

Get your user ID and PIN from your administrator.

Procedure

- Step 1** Press **Applications** .
- Step 2** Select **Extension Mobility** (name can vary).
- Step 3** Enter your user ID and PIN.
- Step 4** If prompted, select a device profile.
-

Phone Calls with Mobile Connect

You can use your mobile phone to handle calls that are associated with your desk phone number. This service is called Mobile Connect.

You associate your mobile phone with your desk phone in the Self Care portal, as an additional phone. You can control which calls are sent to your mobile phone.

When you enable additional phones:

- Your desk phone and your additional phones receive calls simultaneously.
- When you answer the call on your desk phone, the additional phones stop ringing, disconnect, and display a missed call message.
- When you answer the call on one additional phone, the other additional phones and desk phone stop ringing and disconnect. A missed call message shows on the other additional phones.
- You can answer the call on an additional phone and switch the call to a desk phone that shares the line. If you do so, the desk phones that share the same line display a `Remote In Use` message.

Enable Mobile Connect

Procedure

- Step 1** Press **Mobility** to display the current remote destination status (Enabled or Disabled).
- Step 2** Press **Select** to change the status.
-

Turn On Mobile Connect from a Desk Phone

Procedure

- Step 1** Press **Mobility** or select **To Mobile** to display the current remote destination status (Enabled or Disabled).
 - Step 2** Press **Select** to change the status.
-

Move a Call from Your Desk Phone to Your Mobile Phone

You can move a call from your desk phone to your mobile phone. The call is still connected to the line on your desk phone, so you cannot use that line for other calls. The line remains in use until the call ends.

Before You Begin

You need to enable Mobile Connect on your desk phone.

Procedure

- Step 1** Press **Mobility**.
 - Step 2** Press **Select** to send a call to your mobile phone.
 - Step 3** Answer the active call on your mobile phone.
-

Move a Call from Your Mobile Phone to Your Desk Phone

You can move a call from your mobile phone to your desk phone. The call is still connected to your mobile phone.

Before You Begin

You need to enable Mobile Connect on your desk phone.

Procedure

- Step 1** Hang up the call on your mobile phone to disconnect the mobile phone, but not the call.
 - Step 2** Press the line on your desk phone within 5 to 10 seconds to resume the call on your desk phone.
-

Transfer a Call from Your Mobile Phone to Your Desk Phone

You can transfer a call from your mobile phone to your desk phone.

Before You Begin

You need to enable Mobile Connect on your desk phone.

Get the access code from your administrator.

Procedure

-
- Step 1** On the mobile phone, enter the access code for the hand-off feature.
 - Step 2** Hang up the call on your mobile phone to disconnect the mobile phone, but not the call.
 - Step 3** Press **Answer** on your desk phone within 10 seconds and start talking on the desk phone.
-

Line Status





Line status indicators allow you to view the state of a phone line that is associated with a speed-dial button.

Your administrator sets up line status indicators on your phone.

Line Status Indicators

Line status indicators allow you to view the state of a phone line that is associated with a speed-dial button.

Your administrator sets up line status indicators on your phone.

Icon	Indicator
	Line is in use.
	Line is idle.
	Line is ringing. (Applies only for the Call Pickup feature.)
	Line is in a do not disturb (DND) state.

Line status indicators can be set up on speed-dial buttons by your administrator and can be used with these features:

Speed Dial

Allows you to monitor the status of (and dial) a specific number on a speed-dial button. If the monitored line is unavailable, the **Line Status** button changes to a normal speed-dial button.

Directed Call Park

Allows you to monitor the line status of and dial a directed call park number on a speed-dial button.

Call Pickup

Allows you to monitor the line status of (and pick up a ringing call on) a ringing call on a speed-dial button.

Your administrator can also set up your phone to play an audible alert when a call rings on the monitored line.

Custom Line Filters

Custom Line Filters enable you to reduce alert activity by filtering it to high-priority lines by allowing you to set the alerting call notification priority on a subset of lines covered by an alert filter. The custom filter generates either traditional pop-up alerts or actionable alerts for incoming calls on the selected lines. For each filter, only the subset of lines under coverage will generate an alert. If a filter is turned off, lines under its coverage will not show alert notifications.

If this feature has been configured, there are three, selectable, filter types available to you:

- All Calls (on all lines)
- Daily schedule
- Custom user

The administrator configures the default line filter, which is visible to you as the Daily schedule filter. Even if the administrator has not configured the default filter, the all calls filter and custom filter options are available to you. If you have not created any custom filters all provisioned lines are covered by the default line filter if it exists, or all calls if it does not.

You cannot edit either the All Calls filter or the Daily schedule filter, but you can use the Daily schedule filter as a template for a new, custom filter by duplicating and then editing the duplicate filter.

You save the custom filters directly to your phone so that you can quickly select and change coverage. You can define a maximum of 20 custom filters, but only one filter may be active at a time.

**Note**

If both the Custom Line Filters and the Actionable Incoming Call Alert features are enabled, actionable call alerts apply only to the lines that are covered by filters.

Add a Line Filter

Procedure

- Step 1** Press **Applications** .
- Step 2** Select **Preferences > Call notifications** and press **Select**.
The current filter displays next to the option.
- Step 3** Highlight **Add new filter** and press **Select**.
The maximum number of custom filters is 20. If you have already created the maximum number of custom filters, delete a filter before continuing with this procedure.
- Step 4** Press **Select** a second time to make the text editable.
- Step 5** Accept the default name for the new filter, or enter a new one.
- Step 6** Select the lines to add to the new filter.
All available lines are displayed in the list. If you require a line that is not in the list, contact your administrator.
- Step 7** Click **Apply**.
- Step 8** To view the filter, press **Back**.
-

Select an Active Line Filter

Procedure

- Step 1** Press **Applications** .
- Step 2** Highlight **Preferences > Call notifications** and press **Select**.
The currently available filter options display.
- Step 3** Highlight the filter to apply and press **Select**.
- Step 4** To create and manage your filters, press **Applications** and select **Preferences > Call notifications** on your phone.
-

Delete a Line Filter

Procedure

- Step 1** Press **Applications** .
 - Step 2** Highlight **Preferences > Call notifications**, and press **Select**.
 - Step 3** Highlight the filter to be deleted and press **Delete**.
-

Duplicate a Line Filter

Procedure

- Step 1** Press **Applications** .
 - Step 2** Highlight **Preferences > Call notifications**, and press **Select**.
 - Step 3** Highlight the filter to be duplicated and press **Duplicate**.
 - Step 4** Highlight the duplicated filter and press **Edit**.
 - Step 5** (Optional) Enter a new name for the filter.
 - Step 6** Add or remove available lines from the filter.
 - Step 7** Click **Apply**.
 - Step 8** To view the filter, press **Back**.
-

Edit a Line Filter

Procedure

- Step 1** Press **Applications** .
 - Step 2** Highlight **Preferences > Call notifications**, and press **Select**.
 - Step 3** Highlight the filter to be edited and press **Edit**.
Note You cannot edit the Daily schedule filter. For more information, contact your administrator.
 - Step 4** (Optional) Enter a new name for the filter.
 - Step 5** Add or remove available lines from the filter.
 - Step 6** Click **Apply**.
 - Step 7** To view the filter, press **Back**.
-

Rename a Line Filter

Procedure

- Step 1** Press **Applications** .
- Step 2** Highlight **Preferences > Call notifications**, and press **Select**.
- Step 3** Highlight the filter to be renamed and press **Edit**.
- Step 4** Enter a new name for the filter.
- Step 5** Click **Apply**.
- Step 6** To view the filter, press **Back**.
-

Hunt Groups

You can use hunt groups to share the call load in organizations that receive many incoming calls.

Your administrator sets up a hunt group with a series of directory numbers. When the first directory number in the hunt group is busy, the system hunts for the next available directory number in the group. The system directs the call to that phone.

If you are a member of a hunt group, you sign in to a hunt group when you want to receive calls. You sign out of the group when you want to prevent calls from ringing on your phone.

Calls in the group call queue display the same call identification number, no matter which group phone accesses the list.

Sign In and Out of a Hunt Group

Sign out of your hunt group to stop receiving calls from it. You continue receiving calls placed directly to you.

Procedure

View the Call Queue in a Hunt Group

You can use the queue statistics to check the status of the hunt group queue. The queue status display provides the following information:

- The phone number used by the hunt group
- Number of queued callers on each hunt group queue

- Longest waiting time

Procedure

- Step 1** Press **Queue Status**.
- Step 2** Press **Update** to refresh the statistics.
- Step 3** Press **Exit**.
-

Barge

Barge allows you to add yourself to nonprivate calls on a shared line. You can convert the call into a conference and add new participants.

Set up Barge Alert

By default, the Barge Alert option is set to Off and you can barge into an eligible shared lined without receiving a prompt. When the Barge Alert is set to On, an alert prompt is displayed.

Procedure

- Step 1** Press **Applications** .
- Step 2** Go to **Preferences**.
- Step 3** At the **Barge Alert** menu item, click **On** to enable the alert or **Off** to enable Barge. By default, the barge alert prompt is toggled Off.
-

Add Yourself to a Call on a Shared Line

Barge allows you to add yourself to non-private calls on a shared line. You can convert the call into a conference and add new participants.

Procedure

Press the red **Line** button for the shared line.
You are added to the call.

Enable Privacy on a Shared Line

Privacy prevents others who share your line from seeing information about your calls.

Privacy applies to all shared lines on your phone. If you have multiple shared lines and privacy is enabled, others cannot view any of your shared lines.

If the phone that shares your line has privacy enabled, you can make and receive calls using the shared line as usual.

Visual confirmation is displayed on your phone screen for as long as the feature is enabled.

Procedure

-
- Step 1** Press **Privacy** to enable the feature.
 - Step 2** Press **Privacy** again to turn off the feature.
-

Toggle Prompt for Barge

By default, the Barge Alert option is set to Off and you can barge into an eligible shared lined without receiving a prompt. When the Barge Alert is set to On, an alert prompt is displayed. Select Yes to barge into the call or No to cancel the barge.

For more information, contact your administrator.

Procedure

-
- Step 1** Press **Applications** .
 - Step 2** Select **Preferences**.
 - Step 3** At the Barge Alert menu item, click **On** to enable the alert or **Off** to enable Barge. By default, the barge alert prompt is toggled Off.
-

Dismiss Barge Alert Prompt Window

When the Prompt for Barge feature is enabled on your phone, you see a pop-up window when you start to barge into a call.

Procedure

Press **No** to cancel the barge, or press any line or session key. The Barge Alert prompt window closes.

- Note** The alert closes automatically if the phone opens a new window, if a new alert window opens, or if the current session is no longer available for barge.

Call Chaperone

Call Chaperone allows an authorized Call Chaperone user (the chaperone) to supervise (chaperone) and record a call. Chaperoned calls have a minimum of three parties: the calling party, the chaperone, and the called party. To determine if you are an authorized chaperone, contact your system administrator.

The chaperone answers a call, creates a conference call, and remains on the conference call to chaperone and record the call. Cisco Unified IP Phones that are set up with the Call Chaperone feature also have a **Record** button.



When the chaperone hangs up the call, the entire conference ends.

The chaperone can perform only the following tasks while chaperoning the call:

- Record the call.
- Conference in one participant. A chaperone can conference the first participant only; subsequent participants can be added to the conference only by the other participants in the conference.
- End the call.

Record Chaperoned Call

Procedure

- Step 1** Answer an incoming call.
The **Record** button  displays if the system determines that the call must be chaperoned and recorded.
- Step 2** Press **Conference**  to create a conference call.
- Step 3** Enter the phone number for the party you want to add and press **Call**.
- Step 4** When the called party answers, press **Conference**.
The conference begins.
- Step 5** Press **Record** to begin recording the conference call.
Alternatively, you can begin recording the call before the conference call is established. In this case, press **Conference** after answering the incoming call. The call gets put on hold automatically, and the recording stops while you set up the conference call. The recording restarts automatically when the conference call is established.
- Step 6** Press **End Call** to end the chaperoned call; all parties are disconnected.
-

Uniform Resource Identifier Dialing

You can place calls using Uniform Resource Identifier (URI) Dialing, using the alphanumeric URI address as a directory number; for example, *bob@cisco.com*. You must enter the URI address to select the contact.

The phone screen displays the call information for the URI call. The phone stores the URI call information in the Call History and the Details page. When you receive a call with a URI address, the URI address is stored in your Call History. Press Redial to call the most recently dialed URI address.

Depending upon how the administrator configures your phone, you may see either the URI or the Directory Number (DN) displayed for the incoming call alerts, call sessions and call history. If the phone is set to display the DN but only the URI is available, then the URI displays. If the phone is set to display the URI and only the DN is available, then the DN displays.



Note URI calls cannot be placed using the soft keypad.

To place an on-hook call using a URI address, you need to press the ABC softkey to switch the keypad mode.

To place an off-hook call using a URI address, the URI address must be stored in your Call History or Speed Dial list.



Note When you enter a URI address to place a call, do not pause for more than 10 seconds between key presses. After 10 seconds of inactivity, the phone assumes that it has the complete address and attempts to place the call.

When you dial or receive a call through URI dialing, the call window and incoming call alert display the complete URI address.

When you enter a URI address, the maximum length is 254 characters. You can enter the complete domain name to override the default domain.

URI dialing works with the other features of your phone:

- You can configure a URI address as a speed dial entry to place a call.
- You can configure the Call Forward All destination using the Speed Dial or Call History entries.
- You can initiate a conference call and add multiple parties using URI Dialing if the URI address is stored in the Speed Dial list or Call History.
- You cannot use URI addresses during Meet Me conferences or for Group Call Pickup.
- You can initiate a transfer call using URI dialing if the URI address is stored in the Speed Dial list or Call History.
- You can monitor the state (in-use or idle) of a call using URI Dialing associated with Speed Dial or Call History.
- You can initiate URI Dialing when a busy or unavailable party becomes available.
- You can hide the display of the URI address information.

- When the phones are connected to the Cisco Unified Communications Manager Express and Survivable Remote Site Telephony (CME/SRST), the URI Dialing functions are disabled. The ABC softkey does not appear on the phone screen.



Advanced Operations

- [Applications, page 95](#)
- [Video Calls and Security, page 96](#)
- [Call Functions, page 96](#)
- [Feature Buttons and Softkeys, page 99](#)
- [Survivable Remote Site Telephony Overview, page 100](#)
- [WLAN Sign-In, page 103](#)
- [VPN client, page 104](#)
- [Plugins, page 107](#)
- [Cisco IP Manager Assistant, page 107](#)

Applications

You can view the applications that are running on your phone, including those that are not under Applications menu; for example, Directories. You may first see the disclaimer required for remote workers, if you have not already accepted it.

View Active Applications

Procedure

- Step 1** Press **Applications** .
- Step 2** Use the Navigation pad and Select button to scroll and select **Running Applications**. The phone displays a list of applications running on the phone including those that are not under the Application menu.
- Step 3** Press **Exit** to return to the Applications screen.
-

Switch to Active Application

Procedure

- Step 1** Press **Applications** .
- Step 2** Use the Navigation pad and Select button to scroll and select **Running Applications**.
- Step 3** Choose a running application and press **Switch To** to open and use the selected application.
- Step 4** Press **Exit** to close the application.
-

Close Active Application

Procedure

- Step 1** Press **Applications** .
- Step 2** Use the Navigation pad and Select button to scroll and select **Running Applications**.
- Step 3** Select a running application and press **Close App** to close the application.
- Press **Close** to close the application without saving the changes.
 - Press **Cancel** to cancel the close application operations.
- Step 4** Press **Exit** to return back to the Applications screen.
-

Video Calls and Security

Your administrator can take steps to protect your video calls from tampering by people outside your company. If you see the **Secure** icon displayed during a video call, your administrator has taken steps to ensure your privacy.

Call Functions

This section provides information about some of the advanced call functions that are available on your phones.

Agent Greeting

You can create and update a prerecorded greeting that plays at the beginning of a call, such as a customer call, before you begin a conversation. You can prerecord a single greeting or multiple greetings as needed.

When a customer calls, both parties hear the prerecorded greeting. You can remain on mute until the greeting ends, or you can answer the call over the greeting.

Alert Calls

The Alert Calls feature allows you to view a list of all Alert Calls in chronological order (oldest to most recent). You interact with this feature using a programmable line key, which makes it easier to view all of the Alert Calls that are received across your phone lines.

An Alert Call is a specific phone number that you consider important and want to be alerted to when you receive a call from or make a call to this number.

System administrators set up the Alert Calls button. For more information, contact your system administrator.

Actionable Incoming Call Alert

The Actionable Incoming Call Alert displays an actionable alert instead of a toast alert when you receive an incoming call. In addition to displaying incoming caller details, the actionable alert allows you to answer, ignore, or divert the call.

Your administrator configures the Actionable Incoming Call Alert. By default, this actionable alert is disabled.

**Note**

If both the Custom Line Filters and the Actionable Incoming Call Alert features are enabled, actionable call alerts apply only to the lines that are covered by filters.

Answer

Answer allows you to answer the oldest call that is available on all line appearances on your phone, including Hold Reversion and Park Reversion calls that are in an alerting state. Incoming calls always have priority over Held or Park Reversion calls.

Your system administrator sets up the **Answer** button depending on your call-handling needs and work environment. Typically, the Answer is set up if you have multiple lines.

When you get a call, you see a notification window on the phone screen, called a call toast. The call toast remains visible for a preset amount of time. Your system administrator sets up the default time. Your administrator can also enable an interactive notification alert window, called an Actionable Incoming Call Alert, that enables you to directly answer, dismiss or divert a call.

If an incoming call has been call forwarded from another phone, you may see additional information in the call toast to identify that the call has been forwarded. Your system administrator controls the amount of additional information displayed. Additional information can identify the person who forwarded the call to you and the caller information.

Incoming calls can be filtered using Custom Line Filters. You can create up to twenty custom line filters or use the preset ones. Default line filters are configured by an administrator.

Related Topics

[Custom Line Filters](#)

[Actionable Incoming Call Alert](#), on page 97

Client Matter Code

Your administrator may require that you enter a Client Matter Code (CMC) after you dial a phone number. The CMC can be used for accounting or billing codes.

When a CMC is required, the phone displays `Enter Client Matter Code`, the dialed number changes to `*****`, and you hear a special tone. Use the keypad to enter the CMC for the call.

Related Topics

[Forced Authorization Code](#), on page 98

Forced Authorization Code

Your administrator may require that you enter a Forced Authorization Code (FAC) after you dial a phone number. The FAC controls access to phone numbers.

When a FAC is required, the phone displays `Enter Authorization Code`, the dialed number changes to `*****`, and you hear a special tone. Use the keypad to enter the FAC for the call. For security reasons, the phone displays a `*` instead of the number entered.

Related Topics

[Client Matter Code](#), on page 98

Secure Calls

Your administrator can take steps to protect your calls from tampering by people outside your company. When a lock icon is displayed on your phone during a call, your phone call is secure. Depending upon how your phone is configured, you may have to sign on before you make a call or before a security tone plays over your handset.

Shared Lines

You can use one phone number for multiple phones and either you or your coworker can answer the call. When the line flashes red, your coworker can pick up the call.

If you share a line with a coworker and:

- A call comes in on the shared line, the following occurs:
 - Your phone rings, the line button is solid amber, and the session button flashes amber.
 - Your coworker's phone rings, the line button is solid amber, and the session button flashes amber.
- Your coworker has a call on the shared line, the following occurs:
 - If your coworker has privacy enabled, the shared line and the session buttons are solid red; the call information does not display on your phone.

- If your coworker does not have privacy enabled, the shared line and the session button are solid red; the call information (name and number, if available) displays on your phone.
- You put the call on hold, the following occurs:
 - Your line button is solid green and the session button pulses green
 - Your coworker's line button is solid red and the session button pulses red.

Feature Buttons and Softkeys

Depending on how your system administrator set up your phone, some features included in this guide may not be available to you.

The following table provides information about some of the features that are available on softkeys and dedicated feature buttons and some that your system administrator can set up on programmable feature buttons. Features that appear on softkeys are set up by your system administrator.

Feature Name	Dedicated Feature Button	Programmable Feature Button	Softkey
Alert Calls		X	
All Calls		X	
Answer		X	
Assured Services for SIP Lines			X
Call Back		X	X
Call Forward All		X	X
Call Park		X	X
Call Park Line Status		X	
Call Pickup		X	X
Call Pickup Line Status		X	
Conference	X		X (available only while on a conference)
Divert			X
Do Not Disturb		X	
Group Pickup		X	X

Feature Name	Dedicated Feature Button	Programmable Feature Button	Softkey
Hold	X		
Hunt Groups		X	
Intercom		X	
Malicious Call Identification (MCID)		X	X
Meet Me		X	X
Mobile Connect		X	X
Mute	X		
Other Pickup		X	X
Privacy		X	
Quality Reporting Tool (QRT)		X	X
Redial		X	X
Speed Dial		X	X
Speed Dial Line Status		X	
Support for Hold Button on USB Headset			X
Transfer	X		X (available only during a transfer)

**Note**

For details on softkeys used with Cisco IP Manager Assistant (IPMA), see [Manager Phones](#), on page 107 and [Assistant Phones](#), on page 110.

Survivable Remote Site Telephony Overview

If communication between your phone and the Cisco Unified Communications Server is interrupted, you receive an alert message on your phone. If you are on an active call, the call remains established, and you enter a failover situation. This failover is the Survivable Remote Site Telephony (SRST) feature.

While in failover, not all the features of your phone are available. The following table describes typical feature and feature availability, although not all the features may be supported on your phone. For more information about feature availability during failover, contact your system administrator.



Note SRST does not support IPv6.

Table 1: Feature support during failover

Feature	Supported	Notes
New Call	Yes	
End Call	Yes	
Redial	Yes	
Answer	Yes	
Hold	Yes	
Resume	Yes	
Conference	Yes	
Conference to Active Calls (Join)	No	The Active Calls softkey does not display.
Conference List	No	
Transfer	Yes	
Transfer to Active Calls (Direct Transfer)	No	
Auto Answer	Yes	
Call Waiting	Yes	
Caller ID	Yes	
Audible Message Waiting Indicator	Yes	
All Calls Programmable Line Key	Yes	
Answer Programmable Line Key	Yes	
Unified Session Presentation	Yes	Conference is the only feature supported.

Feature	Supported	Notes
Voicemail	Yes	Your voicemail will not be synchronized with other users in the Cisco Unified Communications Manager cluster.
Speed Dial	Yes	
Service IRL Programmable Line Key	Yes	
To Voicemail (iDivert)	No	The iDivert softkey does not display.
Line Filters	Partial	Lines are supported but cannot be shared.
Park Monitoring	No	The Park softkey does not display.
Barge	No	You see the message "That feature is not currently available."
Enhanced Message Waiting Indication	No	Message count badges do not appear on the phone screen. Only the Message Waiting icon displays.
Directed Call Park	No	The softkey does not display.
BLF (Line Status) BLF Speed Dial	Yes	
Hold Reversion	No	Calls remain on hold indefinitely.
Remote Hold	No	Calls appear as Local Hold calls.
Meet Me	No	The Meet Me softkey does not display.
PickUp	No	The softkey causes no action.
Group PickUp	No	The softkey causes no action.
Other PickUp	No	The softkey causes no action.
Malicious Call ID	No	The softkey causes no action.
QRT	No	The softkey causes no action.

Feature	Supported	Notes
Hunt Group	No	The softkey causes no action.
Intercom	No	The softkey causes no action.
Mobility	No	The softkey causes no action.
Privacy	No	The softkey causes no action.
Call Back	No	The Call Back softkey does not display.
Shared line	No	
Video	Yes	Video conference is not supported.
BLF Speed Dial	Yes	

When your phone loses connectivity, your phone may display a message like this: *Service interruption. Some features unavailable.*



WLAN Sign-In

Before you can access the WLAN network, you must sign in. Your system administrator sets up your phone for Wi-Fi connectivity. For information about enabling WLAN on your phone, the WLAN security modes available on your phone, and the site survey that displays the access point information, contact your system administrator.

Sign In to WLAN



Procedure

-
- Step 1** Press **Applications** .
- Step 2** Use the Navigation pad and Select button to scroll and select **Wireless Sign in**.
- Step 3** Press **Sign in**.
After a successful login, the phone displays the Wi-Fi signal strength in the top right corner of the phone screen.
- Your phone notifies you about any Wi-Fi issues by displaying a visual notification on the phone screen. See the table below for the different types of Wi-Fi signals that appear on your phone.

Icon	Description
	No access point detected
	Access point detected
	Access point signal levels 1–4

Change WLAN Sign-In

Procedure

-
- Step 1** Press **Applications** .
- Step 2** Use the Navigation pad and Select button to scroll and select **Wireless Sign in**.
- Step 3** Press **Select** and from the keypad, enter a user ID.
Use  to delete what is in the User ID field. Use the keypad to enter a user ID.
- Step 4** Press the down arrow on the **Navigation pad** to enter a password.
- Step 5** Press **Select** and from the keypad, enter a password.
- Step 6** Press **Sign-in**.
-

VPN client

The VPN Client establishes a virtual private network (VPN) connection on your phone when a phone is located outside a trusted network or when network traffic crosses untrusted networks. Your system administrator configures the VPN Client feature as needed.

If your phone is configured for VPN Client, the status of Auto-Detect Network Connection determines if a VPN connection is possible. The status depends on the following situations:

- When your phone is located outside the corporate network:
 - If Auto-Detect Network Connection is disabled, a VPN connection is possible. The Sign In screen appears, and the phone prompts for credentials. On the phone in the VPN window (**Applications** > **VPN**), you can toggle the **VPN Enabled** field to control the ability of the phone to attempt a VPN connection.

- If Auto-Detect Network Connection is enabled, the Sign In screen appears, and the phone prompts for your credentials, based on the authentication method that your system administrator configured on your phone.
- When your phone is located inside the corporate network:
 - If Auto-Detect Network Connection is disabled, a VPN connection is possible. The Sign In screen appears, and the phone prompts for credentials. On the phone in the VPN window (**Applications > VPN**), you can toggle the **VPN Enabled** field to control the ability of the phone to attempt a VPN connection.
 - If Auto-Detect Network Connection is enabled, you cannot connect through VPN, so the Sign In screen does not appear, and the phone does not prompt for credentials.

To view VPN status messages, press **Applications**  and then select **Administrator Settings > Status > Status Messages**. For more information, contact your system administrator.

The Virtual Desktop Infrastructure (VDI) client attaches to the phone. It provides a virtual environment that allows you to work and collaborate from any device and location at any time.

You must use the Cisco IP Power Cube on the phone in order to use the VDI client.

For more information, see the VDI documentation.

VPN Connection Settings

The VPN window (**Applications > VPN**) consists of these fields:

- Enable or disable VPN: If Auto-Detect Network Connection is disabled, toggle the VPN Enabled field to control the ability of the phone to attempt a VPN connection.
- Change credentials: Select **Change Credentials** to change the user ID and password. If the authentication is certificate-only or VPN Enabled is Off, the option is dimmed.
- View VPN status: The VPN Status field displays *Connected* or *Not Connected*.

Connect Through VPN

Procedure

-
- Step 1** After you turn on your phone and the VPN Sign In screen appears (except with certificate authentication mode), enter your credentials based on the configured authentication method:
- Username and password: Enter the username and the password that your system administrator gave you.
 - Certificate and password: Enter the password that your system administrator gave you. Your username is derived from the certificate.
 - Certificate: If the phone uses only a certificate for authentication, the Sign In screen does not appear, and phone displays the status of the phone attempting the VPN connection.

When the power is lost or reset under some circumstances, the stored credentials are cleared.

Step 2 Select **Sign In** to connect.

If you press **Cancel** while the phone is attempting the connection, the connection attempt stops, and the Sign In screen appears again. If you press **Cancel** again, the VPN menu appears and shows the VPN Enabled field as Off. The phone will not attempt a VPN connection again until you set the VPN Enabled field to On.

Change Your VPN to Another Network

When you are off-premises and your VPN is configured to connect to your company Cisco Unified Communications Manager (Cisco UCM), you can switch your phone to another Cisco UCM.

Before You Begin

Disable the VPN before you change networks.

Procedure

- Step 1** Select **Applications** .
 - Step 2** Select **Administer settings > Network setup > IPv4 setup**.
 - Step 3** Set DHCP to **On**.
 - Step 4** Set Alternate TFTP to **Yes**.
 - Step 5** Enter the new TFTP server IP in the TFTP server 1 field.
 - Step 6** Select **Apply**.
-

Cisco VXC VPN

The Cisco VXC VPN provides integrated VPN functionality for Cisco Virtualization Experience Clients (Cisco VXC) 2111 and 2112. The feature enables VPN tunneling for the Cisco VXC 2111 and Cisco VXC 2112 clients when they are attached to a Cisco Unified IP Phone.

Your administrator must enable the Cisco VXC VPN functionality. You can then start the VPN connection for the Cisco VXC by signing in to the VPN for the attached IP phone.

Your administrator can set up the phone to direct all traffic across one shared VPN tunnel or split the phone and Cisco VXC traffic between two separate tunnels. In the latter case, your administrator can also set up the phone to prompt you to sign in only once to establish both tunnels or to sign in separately for each tunnel.

Whether you are using single or dual tunnels, the VXC VPN Status appears as *Connected* when the Cisco VXC is successfully connected to a VPN tunnel.

Status and statistics

To view Cisco VXC VPN status messages:

To view Cisco VXC VPN status messages, choose **Applications > VPN**, and check the VXC VPN Status field.

To view VXC VPN statistics, choose **Applications > Administrator Settings > Status > VPN Statistics**.

For more information, contact your system administrator.

Plugins

Plugins allow you to download and access applications that your system administrator sets up for you.

For more information, contact your system administrator.

Cisco IP Manager Assistant

Cisco IP Manager Assistant (IPMA) provides call routing and other call management features to help managers and assistants handle phone calls more effectively. The IPMA call routing service intercepts calls that are made to managers and routes them to specified assistants, to other managers, or to targets defined by preconfigured call filters. A manager can change the call routing dynamically.

IPMA has three key components:

Manager

A manager is the user whose incoming calls are intercepted by the call routing service.

Assistant

An assistant is the user who handles calls on behalf of a manager.

Assistant Console

The assistant console is a desktop application that can be used by assistants to perform tasks and manage most features.

Your system administrator configures IPMA to function in shared-line mode or in proxy-line mode. If your phone is configured in shared-line mode, the assistant phone and the manager phone share the same directory number. In proxy-line mode, the assistant has a primary line and proxy lines to handle calls for managers.

Manager Phones

The manager phone makes all manager features available with the exception of Manager Configuration. Managers access the Manager Configuration feature using the web. Your system administrator provides the URL. Use Manager Configuration to set the default assistant, redirect target, inclusive filters, and exclusive filters.

To be designated a manager phone, the phone must have a line with a directory number. An intercom line is optional. If an intercom line is enabled, the current active assistant is the target for the intercom. If there are no active assistants, no speed dial target exists for the intercom.

The manager accesses the Assistant Watch, Intercept Call, Divert, and Transfer to Voice Mail features from the phone softkeys.

IPMA automatically logs in a manager when the Cisco IP Manager Assistant service starts. To access Assistant Services, the manager phone needs to subscribe to the Assistant Primary Phone Service. You subscribe to services from the Application Menu.

If you require enhanced privacy, you can request that any assistant phones do not include private information. Your system administrator can set your phone so that your assistant sees one of the following on their phone:

- The private call displays `Private` along with the call status (but no call duration).
- (Default) The private call does not display.

You can also request that your administrator set up your assistant phones so that your private calls are handled in the Call History of their phones in this manner

- (Default) The log record for the private call displays `Private`.
- The log record for the private call is not saved.

Manager Status Window

The Manager Status window is divided into the Assistant Watch area and the Assistant and Features area. The Assistant Watch area is located at the top of the status window and displays the caller ID as well as the elapsed time for an active call handled by an assistant. The Assistant and Features area displays icons to indicate the presence of an active assistant and icons to display the status of manager features. If a feature is turned off, the feature icon displays a red, barred circle.



Note

In shared-line mode, the Assistant Watch area is hidden, and only Do Not Disturb is available in the Assistant and Features area.

Assistant Watch status messages are displayed in the title bar of the Assistant Watch area.

Table 2: Assistant Watch Messages

Message	Meaning
Assistant Watch - On	Assistant Watch is on but no connected or incoming calls are being redirected to the assistant at this time.
Assistant Watch - Off	Assistant Watch is off. To toggle it on, press Set Watch.
Call from followed by caller ID	An incoming call was redirected to the assistant and is currently ringing on the assistant's phone. The manager can intercept the call.
Caller ID and a timer	The assistant answered the incoming call. The timer begins when the assistant answers, or otherwise handles, the call.
Filtering Down	Call Filtering is unavailable at this time.

Related Topics

[Subscribe to Assistant Primary Phone Service, on page 109](#)

Manager Settings Menu

The following table describes the manager phone options configured in the Manager Settings menu.

Table 3: Manger Settings Menu Options

Menu Option	Description
Filter	Toggles call filtering off and on.
Filter Mode	Toggles between Inclusive or Exclusive filters.
Assistant	Displays the active assistant. The manager can select other available assistants from this option. See Select Assistant, on page 109 .
Alert Tone	Toggles alert off and on. Alert tone plays an audio alert to incoming calls on the manager phone if the call is routed to the assistant phone.

Select Assistant**Procedure**

-
- Step 1** Press **Applications**.
 - Step 2** Select the appropriate Assistant Phone Service menu item.
The Manager Settings menu opens.
 - Step 3** Select the Assistant option.
If more than one assistant is available, all associated assistants display.
 - Step 4** Select the desired assistant.
-

Subscribe to Assistant Primary Phone Service**Procedure**

-
- Step 1** Press **Applications**.
 - Step 2** Select **Assistant Pri Svc** or press **6** on the keypad.
If necessary, subscribe to the Assistant Secondary Phone Service.
-

Assistant Phones

Assistants access the IPMA features on the computer using the Assistant Console application or directly on the assistant phone through phone services and softkeys.

Your administrator configures IPMA in either proxy-line or shared-line mode. In shared-line mode, the assistant phone and the manager phone share a single directory number. In proxy-line mode, the assistant phone has a primary line and proxy lines to handle calls for manager phones.

To access Assistant Services, the assistant phone needs to subscribe to the Assistant Primary Phone Service. It may also be necessary to subscribe to Assistant Secondary Phone Services. You subscribe to services from the Application menu.

To handle calls for managers, the assistant phone must log in to the IPMA service. IPMA supports Single Sign On (SSO). If you have logged into the Assistant Console you do not need to log in to the IPMA service on the phone.

A optional intercom line can be configured if required. The intercom line is a dedicated line; it can only be used to speak to a specific manager phone, even if the assistant phone is associated with multiple managers.

Related Topics

[Subscribe to Assistant Primary Phone Service, on page 109](#)

[Log In to IPMA Service on Phone, on page 114](#)

Assistant Console

The Assistant Console is an application interface that can be used by assistants to manage IPMA features and services.

Assistant Settings Menu

You configure some assistant phone options in the Assistant Settings menu. The following table describes the options available in the Assistant Settings menu.

Table 4: Assistant Settings Menu Options

Menu Option	Description
CallPlane OverWrite	Toggles between Enabled and Disabled. Enable this flag to send real time updates while the assistant is on a call. When enabled, a change in a manager's status displays while the assistant is on a call. Use this feature to help determine if a manager is busy before diverting a call to that manager.
Smart Sorting	Toggles between Enabled and Disabled. Enable this flag to sort the manager list on the Assistant Manager Status menu by new call event. If disabled, the ordering of the manager list is static.

Menu Option	Description
Set Divert target	When you press the Redirect softkey, incoming calls for the manager on the assistant phone get diverted to the divert target, which is either the currently selected manager (the default) or a directory number.

Softkeys are used to access and manage a variety of assistant tasks. The following table describes the softkeys available in the Assistant Settings menu.

Table 5: Softkeys in the Assistant Settings window

Softkey	Description
Select	Toggles the settings for CallPlane OverWrite and Smart Sorting. If the Set Divert Target field is highlighted, press Select to display the assistant Divert Target screen.
StpUpdt/StrUpdat	Stops or starts automatic refresh of a manager's status in the Assistant Manager Status window. By default this is enabled (StrUpdat). To prevent automatic refresh, press StpUpdt . Press StrUpdt to start automatic refresh.
Back	Exits the Assistant Settings menu and returns to the Assistant Manager Status window.
LogOut	Logs out the assistant from the IPMA service. To resume using IPMA, the assistant must log back into the IPMA service.

Set Divert Target

Procedure

-
- Step 1** Open the Assistant Manager Status menu.
You may need to log in first.
 - Step 2** Press **AsstSett**.
If **AsstSett** is not visible, press **More**. You may need to press **More** twice.
 - Step 3** Press **Set Divert Target**.
 - Step 4** Enter the directory number.
 - Step 5** Press **Save**.
Pressing **Redirect** routes incoming, connected or on-hold calls to this number.
-

Related Topics

[Log In to IPMA Service on Phone](#), on page 114

[Assistant Settings Menu, on page 110](#)

Enable CallPlane Overwrite

Procedure

- Step 1** Open the Assistant Manager Status menu.
You may need to log in first.
- Step 2** Press **AsstSett** to open the Assistant Settings Menu.
If **AsstSett** is not visible, press **More**. You may need to press **More** twice.
- Step 3** Choose **CallPlane Overwrite** and press **Select**.
- Step 4** Choose **Enable**.
- Step 5** Press **Save**.
-

Related Topics

[Log In to IPMA Service on Phone, on page 114](#)
[Assistant Settings Menu, on page 110](#)

Enable Smart Sorting

Procedure

- Step 1** Open the Assistant Manager Status menu.
You may need to log in first.
- Step 2** Press **AsstSett** to open the Assistant Settings Menu.
If **AsstSett** is not visible, press **More**. You may need to press **More** twice.
- Step 3** Choose **Smart Sorting** and press **Select**.
- Step 4** Choose **Enable** and press **Select**.
- Step 5** Press **Save**.
-

Related Topics

[Log In to IPMA Service on Phone, on page 114](#)
[Assistant Settings Menu, on page 110](#)

Assistant Manager Status Menu

The following information is displayed in the Assistant Manager Status menu:

- Assistant status: indicates if the assistant is online or offline.

- Manager list: displays the call status, line number, and call information for each associated manager.

Softkeys are used to access and manage a variety of assistant tasks. The following table describes the softkeys available in the Assistant Manager Status menu.

Table 6: Softkeys in the Assistant Manager Status Window

Softkey	Description
More	Switches among pages. Press this key if a required key is not visible.
Select	Selects the highlighted manager from the list of managers and opens the Manager Settings window.
Answer	Answer an incoming call for the corresponding manager.
Exit	Exits the Assistant Service.
Redirect	Immediately diverts incoming, connected or on-hold call to the corresponding manager (the default) or to another preset directory number.
TransVm	Sends an incoming, connected, or on-hold call to that manager's voice mailbox.
InterCom	Enables the assistant to speak to a manager on an intercom line.
GoOffLine	Takes the assistant offline. If another assistant is configured for the manager, and if that assistant is online, then that assistant becomes the active assistant for the manager.
AsstSett	Opens the Assistant Settings window. The assistant uses this to configure settings. See Assistant Settings Menu , on page 110.

Related Topics

[Log In to IPMA Service on Phone](#), on page 114

[Set Divert Target](#), on page 111

[Assistant Settings Menu](#), on page 110

[Manager Settings Menu](#), on page 109

Manager Settings Menu on Assistant Phone

The Manager Settings menu is used to manage applicable settings on behalf of each associated manager that appears in the manager list of the Assistant Manager Status window. The available settings depend on whether your phone is configured in shared-line mode or in proxy-line mode.

In shared-line mode, only the Do Not Disturb feature can be set by the assistant.

In proxy-line mode, the Manager Settings menu on the assistant phone is similar to the Manager Settings menu on the manager phone. Note that the assistant cannot specify the active assistant phone for the manager phone, but Do Not Disturb and Divert Calls can be toggled by the assistant. The assistant is also able to set

the manager divert target for the selected manager. If the divert target is set to be blank, then the divert target is saved as `Assistant`.

Log In to IPMA Service on Phone

Procedure

- Step 1** Press **Applications** .
 - Step 2** Select the **Assistant Service** menu option and press **Open**.
 - Step 3** Select **Assistant Login** and press **Open**.
 - Step 4** Enter your User ID.
 - Step 5** Enter your PIN.
 - Step 6** Press **Submit**.
-



CHAPTER 9

User Preferences

- [Adjust Phone Screen Brightness, page 115](#)
- [Adjust Headset Sidetone, page 116](#)
- [Change Ringtone, page 116](#)
- [Change Wallpaper, page 117](#)
- [Change Font Size, page 117](#)
- [Phone Services , page 118](#)
- [Line Settings, page 118](#)

Adjust Phone Screen Brightness

You can adjust your phone screen brightness level.

Procedure

- Step 1** Press **Applications** .
- Step 2** Use the Navigation pad and Select button to scroll and select **Preferences**.
- Step 3** Select **Brightness**.
- To increase brightness, press the right arrow on the Navigation pad.
 - To decrease brightness, press the left arrow on the Navigation pad.
- Step 4** Press **Save** to set the brightness, or press **Cancel** to exit.
-

Adjust Headset Sidetone

If your system administrator has sets the Headset Sidetone Controls feature for your phone, you can specify the volume of your headset from your phone.



Procedure

- Step 1** Press **Applications** .
- Step 2** Use the Navigation pad and Select button to select **Preferences**.
- Step 3** Select **Headset Sidetone**.
- Step 4** Select one of the following sidetone levels:
- Off
 - Very Low
 - Low
 - Normal
 - High
-

Change Ringtone

You can choose a different ringtone for each line that your phone plays to indicate an incoming call. For information about adding custom ringtones to your phone, contact your system administrator.

Procedure

- Step 1** Press **Applications** .
- Step 2** Use the Navigation pad and Select button to scroll and select **Preferences**.
- Step 3** Select **Ringtone**.
- Step 4** If your phone has multiple lines, select a line and press **Edit** or **Select**.
- Step 5** Highlight a ringtone.
- Step 6** Press **Select** or **Edit**.
- Step 7** Press **Play** to play the sample ringtone.
- Step 8** Press **Set** to apply the ringtone.
- Step 9** To apply the ringtone to all lines, press **Apply To All**.
- Step 10** Press **Return**  to return to the Preferences screen.
-

Change Wallpaper

Your system administrator controls if you can change the wallpaper. If you can change the wallpaper, you can set up your phone with wallpapers that are provided with the phone, or with your own custom wallpaper. For more information, contact your system administrator.

Procedure

-
- Step 1** Press **Applications** .
- Step 2** Use the Navigation pad and Select to scroll and select **Preferences**.
- Step 3** Select **Wallpaper** and select a wallpaper option.
- Step 4** Press **Preview** to see the wallpaper on your phone screen.
- Step 5** Press **Set** to apply the wallpaper to the phone.
-

Change Font Size

You can increase or decrease the maximum number of characters the IP phone displays by changing the font size for the displayed characters. To increase the maximum number of displayed characters, select a smaller font size. To decrease the maximum number of displayed characters, select a larger font size.



The font size affects the following labels:

- call screen (caller name and feature key label)
- caller name in Call History
- line label on phone screen
- line label on key expansion module

The following table describes the configuration setting and the corresponding font sizes.

Configuration Setting	Line Label	Call Session: Caller Name	Call Session: Caller Number	Call History	Key Expansion Module
Huge	26 point	26 point	22 point	26 point	23 point
Large (default)	23 point	23 point	22 point	23 point	18 point
Medium	20 point	20 point	22 point	19 point	18 point
Small	16 point	16 point	20 point	19 point	16 point

Procedure





- Step 1** Press **Applications** .
- Step 2** Use the Navigation pad and Select button to scroll and select **Preferences**.
- Step 3** Select **Font Size**.
- Step 4** Choose **Huge**, **Large**, **Medium**, or **Small**.
- Step 5** Press **Return**  to return to the Preferences screen.
-

Phone Services

Phone services can include special phone features, network data, and web-based information (such as stock quotes and movie listings). You need to subscribe to a phone service using the Self Care Portal before you can access it on your phone.

If one service is set up, the service opens by default. If more than one service is set up, select an option from the menu.

Select a service by using one of these feature buttons:

-  (Feature button that your system administrator sets up)
-  **Messages**
-  **Applications**
-  **Contacts**

For information on Cisco Unified Communications Self Care Portal, see the *Cisco Unified Communications Self Care Portal User Guide*, at http://www.cisco.com/c/en/us/td/docs/voice_ip_comm/cucm/useroptions/10_5_1/CUCM_BK_U437D0F8_00_self-care-user-guide-1051.html.

Line Settings

Line settings affect a specific phone line (directory number) on your phone. Line settings can include call forwarding, visual and audio message indicators, ring patterns, and other line-specific settings.

You can use the Cisco Unified Communications Self Care Portal to change your line settings. For information, see the *Cisco Unified Communications Self Care Portal User Guide* at http://www.cisco.com/c/en/us/td/docs/voice_ip_comm/cucm/useroptions/10_5_1/CUCM_BK_U437D0F8_00_self-care-user-guide-1051.html.



Cisco Unified Video Camera

- [Install Cisco Unified Video Camera, page 119](#)
- [View Camera Details, page 121](#)
- [Cisco Unified Video Camera Features, page 121](#)
- [Camera Lens Shutter, page 122](#)
- [Camera Preferences, page 123](#)
- [Reset Camera, page 125](#)

Install Cisco Unified Video Camera

The Cisco Unified Video Camera can be mounted on your Cisco Unified IP Phone 9951 or 9971, or it can be mounted on your computer monitor. If you need help installing or positioning your camera, contact your system administrator.

Mount Camera on Phone

Procedure

- Step 1** Remove the protective plastic from the camera lens and body.
- Step 2** On the phone, remove the small plastic cover located on the topside of the phone display.
- Step 3** With your phone idle (no calls), slide the camera USB connector (on the bottom of the camera) into the Phone USB port (on the back of the phone display).
As you do this, pins on the underside of the camera fit into pinholes on the top of the phone display to further stabilize the camera.

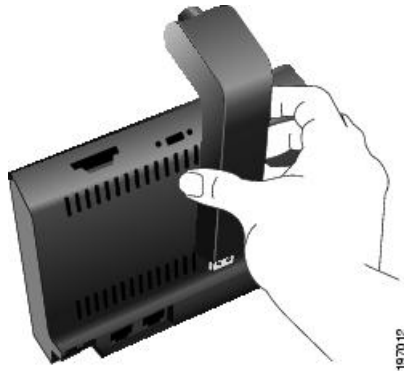

- Step 4** Look for the installation confirmation message on the phone screen.
- Step 5** After installation is complete, adjust the View Area and Brightness settings as needed.
-

Mount Camera on Monitor

Procedure

- Step 1** Obtain a mounting clip and USB extension cable from your system administrator.
- Step 2** Remove the protective plastic from the camera lens and body.
- Step 3** Plug the USB extension cable into the USB port on the back of the phone display.
- Step 4** Place the camera in the mounting clip, as shown in the following figure.

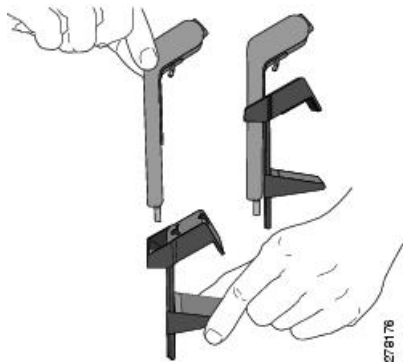

- Step 5** With your phone idle (no calls), attach the USB cable to the USB connector on the bottom of the camera.
- Step 6** Adjust the mounting clip as needed to rest securely on your computer monitor. As shown in the following figure, the mounting clip has two removable sliding supports (small and large). Choose the support that best fits your computer monitor; you can remove the remaining support.

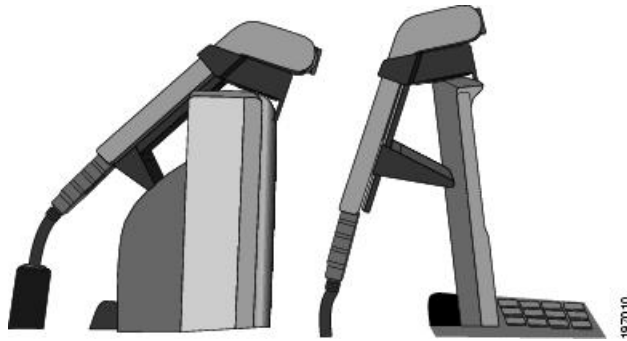



Step 7 Look for the installation confirmation message on the phone screen.

Step 8 After installation is complete, adjust the View Area and Brightness settings as needed.

View Camera Details

Procedure

- Step 1** Press **Applications** .
- Step 2** Use the Navigation pad and Select button to scroll and select **Accessories**.
- Step 3** Select **Cisco Unified Video Camera** and press **Details**.
- Step 4** Press **Return**  to return to the Accessories screen.
-

Cisco Unified Video Camera Features

The Cisco Unified Video Camera includes the following features.

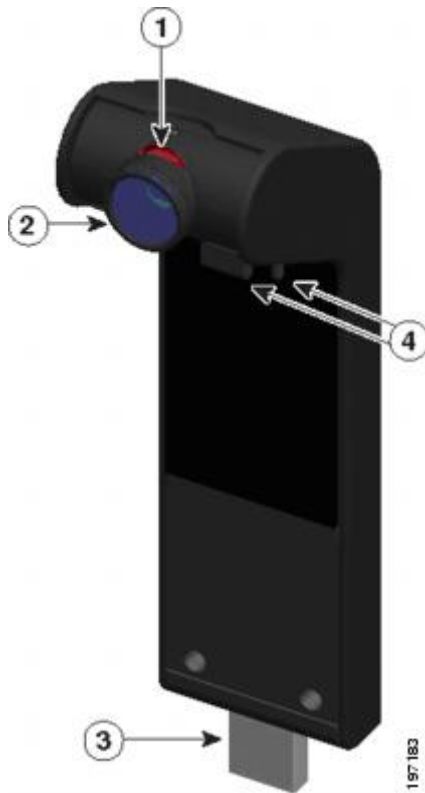

1	LED: Indicates the state of the camera as follows: <ul style="list-style-type: none"> • Video transmitting—Green • Video muted—Red 	2	Camera lens: Swivels up and down to adjust the camera angle. The lens shutter can close to block video transmission.
3	USB connector	4	Mounting pins: Secures the camera to your Cisco Unified IP Phone. The pins fit into the designated slots on top of the phone.

Camera Lens Shutter

The camera lens shutter allows you to physically block video transmission from your camera.

Close Camera Lens Shutter

The following figure shows the location of the camera lens shutter.



Procedure

-
- Step 1** To close the shutter, rotate the lens clockwise.
- Step 2** To open the shutter, rotate the lens counterclockwise.
-

Camera Preferences

Camera preferences allows you to set user preferences for the following items:



- Auto Transmit
- Brightness
- Viewing Areas

Enable Auto Transmit

When Auto Transmit Video is on, the camera streams video automatically during calls.

When Auto Transmit is off, video for each call is automatically muted (however, your phone still receives video).

Procedure



-
- Step 1** Press **Applications** .
- Step 2** Use the Navigation pad and Select button to scroll and select **Accessories**.
- Step 3** Select **Cisco Unified Video Camera**.
- Step 4** Press **Set-up**.
- Step 5** Press **Turn On** to enable the Auto Transmit feature, or press **Return**  to return to the Set-up screen.
-

Adjust Camera Brightness

The brightness setting affects the video that you transmit to others; it does not affect video that you receive from other parties.

Because the field of view can affect brightness, adjust the View Area before adjusting the brightness.

Procedure



- Step 1** Press **Applications** .
- Step 2** Use the Navigation pad and Select button to scroll and select **Accessories**.
- Step 3** Select **Cisco Unified Video Camera**.
- Step 4** Select **Brightness**.
- To increase brightness, press the right or up arrow on the Navigation pad.
 - To decrease brightness, press the left or down arrow on the Navigation pad.
- Step 5** Press **Save** to set the brightness, or press **Return**  to return to the Setup screen.
-

Adjust Camera View Area

The view area acts as a wide angle and zoom function for your camera:

- Increasing the view area allows the camera to capture a wider image field.
- Decreasing the view area acts as a zoom and narrows the image field.

Procedure

- Step 1** Press **Applications** .
- Step 2** Use the Navigation pad and Select button to scroll and select **Accessories**.
- Step 3** Select **Cisco Unified Video Camera**.
- Step 4** Select **View Area**
- To increase the camera viewing area, press the right or up arrow on the Navigation pad.
 - To decrease the camera viewing area, press the left or down arrow on the Navigation pad.
- Step 5** Press **Save** to set the contrast, or press **Return**  to return to the Setup screen.
-

Access Preview Video

Preview Video allows you to see the view from your camera when you are not in a video call. Use Preview Video before making video calls to help set up and position your camera effectively.

Procedure

- Step 1** Press **More**.
 - Step 2** Press **Preview Video**.
-

Enable Video

The Enable Video On/Off settings in the phone menu controls the video capability of the phone. If you enable video, you identify the phone as being capable of sending and receiving video. If you disable video, your calls use only audio. Your system administrator controls the ability to use video for calls.

Follow these steps to turn this feature on or off:

Procedure

- Step 1** Press **Applications** .
 - Step 2** Use the Navigation pad and Select button to select **Preferences > Video**.
 - Step 3** Press **On/Off** softkey or **Select** button to toggle video on or off.
-

Reset Camera

Procedure

- Step 1** Press **Applications** .
 - Step 2** Use the Navigation pad and Select button to scroll and select **Accessories**.
 - Step 3** Select **Cisco Unified Video Camera** and press **Reset**.
The phone resets the default configuration of the Cisco Unified Video Camera.
 - Step 4** Press **Cancel** to return to the Accessories screen.
-



Accessories

- [Accessory Support](#), page 127
- [Important Headset Safety Information](#), page 128
- [View Accessories List](#), page 128
- [View Accessories Details](#), page 129
- [USB Devices](#), page 129
- [Set Up Wideband for Analog Headset](#), page 130
- [Bluetooth Headsets](#), page 130
- [Cisco Unified IP Color Key Expansion Module](#), page 133

Accessory Support

Your phone supports accessories from Cisco and third-party manufacturers.

Accessory	Type	Cisco Unified IP Phone		
		8961	9951	9971
Cisco Accessories				
Cisco Unified IP Color Key Expansion Module	Add-on module	X	X	X
Cisco Unified Camera	Add-on module	—	X	X
Virtual desktop infrastructure (VDI) client	Add-on module	X	X	X
Third-Party Accessories				

Accessory	Type	Cisco Unified IP Phone		
		8961	9951	9971
Headset	Analog	X	X	X
	Analog Wideband	X	X	X
	Bluetooth	—	X	X
	USB	X	X	X
Microphone	External PC	—	X	X
Speakers	External PC	—	X	X

Important Headset Safety Information



High Sound Pressure—Avoid listening to high volume levels for long periods to prevent possible hearing damage.

When you plug in your headset, lower the volume of the headset speaker before you put the headset on. If you remember to lower the volume before you take the headset off, the volume will start lower when you plug in your headset again.

Be aware of your surroundings. When you use your headset, it may block out important external sounds, particularly in emergencies or in noisy environments. Don't use the headset while driving. Don't leave your headset or headset cables in an area where people or pets can trip over them. Always supervise children who are near your headset or headset cables.

View Accessories List

You can connect external hardware to your phone using the headjack, Bluetooth, or USB. The accessory list, by default, contains an analog headset that can be set up to enable wideband.

Procedure

-
- Step 1** Press **Applications** .
 - Step 2** Use the Navigation pad and Select button to scroll and select **Accessories**.
A list of phone accessories displays.
 - Step 3** Press **Exit** to return to the Applications screen.
-

View Accessories Details

Procedure

- Step 1** Press **Applications** .
- Step 2** Use the Navigation pad and Select button to scroll and select **Accessories**.
A list of phone accessories displays.
- Step 3** Select an accessory from list and press **Details**.
The phone screen displays the details of selected accessory. The information displayed on the phone screen depends on the accessory selected. Most of the accessories provide these details:
- Device Name
 - Hostname
 - Device Type
 - Device Service
 - Firmware Version
 - Paired Status (for Bluetooth devices)
 - Connected Status
 - Configured Status
- Step 4** Press **Setup** to configure the selected accessory for your phone.
- Step 5** Press **Exit** to return to the Applications screen.
-

USB Devices



Each USB port supports a maximum of five supported and nonsupported devices that are connected to the phone. Each device connected to the phone is included in the maximum device count.

For example, your phone can support five USB devices (such as three Cisco Unified IP Color Key Expansion modules, one hub, and one other standard USB device) on the side port and five additional standard USB devices on the back port. Many third-party USB products contain more than one USB device, and thus count as more than one device. For example, a third-party USB device may contain an internal hub and a headset, and thus count as two USB devices.

If you use a USB hub and remove the USB cable from the phone or device port during an active call, it may cause your phone or device to reboot. For more information, contact your system administrator.

Set Up Wideband for Analog Headset

Procedure

- Step 1** Press **Applications** .
- Step 2** Use the Navigation pad and Select button to scroll and select **Accessories**.
A list of phone accessories displays.
- Step 3** Select **Analog Headset** and press **Setup**.
The phone screen displays the wideband status for the analog headset.
- Step 4** To enable wideband for the analog headset, press **Turn On**.
- Step 5** To disable wideband for the analog headset, press **Turn Off**.
- Step 6** Press **Return**  to return to the Accessories screen.
-

Bluetooth Headsets

(For Cisco Unified IP Phone 9951 and 9971 only.)

Your phone supports Bluetooth Class 2 technology when the headsets support Bluetooth. You can add and pair up to five Bluetooth headsets to your phone, but the last Bluetooth headset connected becomes the default for use with the phone.

The Cisco Unified IP Phone 9951 and 9971 support Bluetooth Class 2 technology when the headsets support Bluetooth. Bluetooth enables low-bandwidth wireless connections within a range of 30 feet (10 meters). The best performance is in the 3- to 6-foot (1- to 2-meter) range.

When using Bluetooth headsets with your phone, these conditions apply:

- You can pair and connect up to five Bluetooth headsets to your phone, but the last Bluetooth headset connected becomes the default for use with the phone.
- After a Bluetooth headset is connected, turning it off and on reconnects it to the phone. The following instructions apply when using the Bluetooth headset:
 - If you have both a Bluetooth headset and an analog headset attached to the phone, only one type of headset works at any time. Using a USB headset disables both the Bluetooth and analog headset.
 - Enable the Bluetooth headset to disable the analog headset.
 - Disable the Bluetooth headset to enable the analog headset.
 - Unplug the USB headset and then enable either the Bluetooth headset or the analog headset.
- For optimum headset coverage, use your Bluetooth headset within 10 ft. of the phone, although Bluetooth coverage extends to about 30 ft from the phone.
- Your phone supports the Bluetooth Handsfree Profile. If your Bluetooth headset supports these features, you can perform these call functions from your Bluetooth headset:

- Answer a call
- End a call
- Change the headset volume for a call
- Redial
- Caller ID
- Reject
- Divert
- Hold and Accept
- Release and Accept

For more information, see the documentation from your Bluetooth headset manufacturer.

While using Bluetooth headset, there can be potential interference issues. Therefore Cisco recommends that you reduce the proximity of other 802.11b/g devices, Bluetooth devices, microwave ovens, and large metal objects.

For a Bluetooth wireless headset to work, it does not need to be within direct line-of-sight of the phone, but some barriers, such as walls or doors, and interference from other electronic devices, can affect the connection.

Add Bluetooth Accessory

Before you add a Bluetooth accessory, it must be discoverable by the phone. Look for a flashing LED on a Bluetooth accessory as an indication that it is discoverable. For more information, see the documentation from the Bluetooth accessory manufacturer.

(For Cisco Unified IP Phone 9951 and 9971 only.)

Procedure

- Step 1** Press **Applications** .
- Step 2** Use the Navigation pad and Select button to scroll and select **Accessories**.
- Step 3** Select **Add Bluetooth Accessory**.
The phone searches for discoverable accessories that are supported. When an accessory is found, it is added to the list in the Adding Bluetooth Accessory screen.
- Step 4** Select the accessory and press **Connect**.
The phone automatically attempts to connect the accessory using a Bluetooth device PIN of "0000".
- Step 5** If your accessory requires a different PIN and the Adding PIN screen appears, enter the PIN for your accessory.

When the connection completes, the Bluetooth active icon  appears on the phone screen header and a checkmark appears next to the connected accessory.

Connect Bluetooth Accessory

(For Cisco Unified IP Phone 9951 and 9971 only.)

Before You Begin

Before you can connect a Bluetooth accessory, it must be already added as an accessory to the phone.

Procedure

- Step 1** Press **Applications** .
- Step 2** Use the Navigation pad and Select button to scroll and select **Accessories**.
- Step 3** Select a Bluetooth accessory and press **Connect**.





When the connection completes, the Bluetooth active icon  appears on the phone screen header and a checkmark appears next to the connected accessory.

Turn on Bluetooth

If your system administrator has set up the Bluetooth feature for your phone, you can turn it on and off from your phone.

(For Cisco Unified IP Phone 9951 and 9971 only.)

Procedure

- Step 1** Press **Applications** .
- Step 2** Use the Navigation pad and Select button to scroll and select **Preferences**.
- Step 3** Select **Bluetooth**.
- Step 4** Press **On**.
- The **Bluetooth icon**  appears on the phone screen header.
- Step 5** (Optional) To add a Bluetooth accessory from this screen, select **Bluetooth** again and press **Add Accessory**.
- Step 6** To turn off Bluetooth, press **Applications** .
- Step 7** Use the Navigation pad and Select button to scroll and select **Preferences**.
- Step 8** Select **Bluetooth**.
- Step 9** Press **Off**.
- The Bluetooth icon  disappears from the phone screen header.
-

Disconnect Bluetooth Accessory

(For Cisco Unified IP Phone 9951 and 9971 only.)

Procedure

-
- Step 1** Press **Applications** .
- Step 2** Use the Navigation pad and Select button to scroll and select **Accessories**.
- Step 3** Select a Bluetooth accessory and then press **Disconnect**.
-

Delete Bluetooth Accessory

(For Cisco Unified IP Phone 9951 and 9971 only.)

Procedure

-
- Step 1** Press **Applications** .
- Step 2** Use the Navigation pad and Select button to scroll and select **Accessories**.
- Step 3** Select a Bluetooth accessory and press **Delete**.
The Bluetooth accessory disconnects (if it was connected) and does not display on the Accessories list.
-

Cisco Unified IP Color Key Expansion Module

The Cisco Unified IP Color Key Expansion Module attaches to your Cisco Unified IP Phone 8961, 9951, and 9971 and allows you to add up to 36 extra line appearances or programmable buttons to your phone. The programmable buttons can be set up as phone line buttons, speed-dial buttons, or phone feature buttons.

You can add multiple Expansion Modules to the Cisco Unified IP Phone 9951 and Cisco Unified IP Phone 9971.

Cisco Unified IP Phone model	Number of Expansion Modules supported
8961	1 Expansion Module with 36 lines or buttons
9951	2 Expansion Modules with 72 lines or buttons
9971	3 Expansion Modules with 108 lines or buttons

When multiple Expansion Modules are attached, they are numbered according to the order in which they are connected to the phone. For example:

- Key Expansion Module 1 is the Expansion Module closest to the phone.
- Key Expansion Module 2 is the Expansion Module in the middle.
- Key Expansion Module 3 is the Expansion Module farthest to the right.

The following figure shows a Cisco Unified IP Phone 9971 with three Cisco Unified IP Color Key Expansion Modules.



Cisco Unified IP Color Key Expansion Module Features

The Cisco Unified IP Color Key Expansion Module includes the following features.



1	<p>Phone screen: Displays the phone number, speed-dial number (or name or other text label), phone service, phone feature, or Privacy assigned to each button.</p> <p>Icons indicating line status appear similar to, and function the same as, those on the Cisco Unified IP Phone to which the Key Expansion Module is attached.</p>
2	<p>Lighted Buttons: 18 line buttons. Each button corresponds to one line (as with the Cisco Unified IP Phone). The lights beneath each button indicate the state of the corresponding line as follows:</p> <ul style="list-style-type: none"> • Line available: light off • Line in use by you: solid green light • Line in use by someone else: solid red light • Line ringing: solid amber light • You have a call on hold: solid green light • Someone else has a call on hold on a shared line: solid red light • Call transfer: solid green light • Call is ringing on an inactive page: solid amber light
3	<p>Shift Buttons: 2 buttons. Each button corresponds to one page of 18 line keys. The button for page one is labeled with the number 1 and the button for page two is labeled with the number 2. The lights beneath each button indicate the state of the page as follows:</p> <ul style="list-style-type: none"> • Page is in view: solid green light • Page is not in view: light off • Page is not in view, with one or more alerting calls on the page: solid amber light • Page is in view with one or more alerting calls on the page: solid green light • A call is ringing on an inactive page: flashing amber light

Place a Call on the Key Expansion Module

Procedure

-
- Step 1** Press the line button on the key expansion module.
- Step 2** Dial a phone number.
- Step 3** Pick up your handset.
-

Key Expansion Module Button Setup

You can use the Self Care Portal to configure your speed-dial numbers or program buttons to access phone services. Phone services can include weather, stock quotes, or corporate calendars and directories.

Adjust the Key Expansion Module Screen Brightness

Procedure

- Step 1** Press **Applications** .
 - Step 2** Select **Preferences > Brightness > Key Expansion Module**.
 - Step 3** Press right on the Navigation pad to increase brightness. Press left on the Navigation pad to decrease brightness.
 - Step 4** Press **Save**.
-



Frequently Asked Questions

- [Why Can't I See All Active Calls on My Phone?, page 138](#)
- [How Do I Redirect an Incoming Call?, page 138](#)
- [How Do I Silence a Ringing Call If I'm On a Call?, page 138](#)
- [How Do I Resume a Call that is On Hold?, page 138](#)
- [What Is the Difference Between Buttons on the Left and Those on the Right of the Screen?, page 139](#)
- [Why Do Softkeys Keep Changing?, page 139](#)
- [What Is the Best Way to Look at Calls When I Have a Shared Line or Multiple Lines?, page 139](#)
- [What Should I Do If I Accidentally Press a Button While on a Call?, page 140](#)
- [How Do I Check Missed Calls?, page 140](#)
- [How Do I Exit from a Running Application?, page 140](#)
- [How Do I Connect Two Calls and then Drop from the Line Myself?, page 141](#)
- [What Does the Swap Softkey Do?, page 141](#)
- [How Do I Cancel a Conference or Transfer After I Start It?, page 142](#)
- [How Can I Combine Two Calls Into a Single Conference Call?, page 142](#)
- [Where Should I Mount My Cisco Unified Video Camera?, page 142](#)
- [How Can I Prevent Theft of my Cisco Unified Video Camera?, page 142](#)
- [Why can I not see video on a call?, page 143](#)
- [What Does the Preview Softkey Do?, page 143](#)
- [What Happens to Video When I Put a Call On Hold?, page 143](#)
- [What Do the Light Colors on My Cisco Unified Video Camera Indicate?, page 144](#)
- [How Do I Close the Shutter on my Cisco Unified Video Camera?, page 144](#)
- [Why Does the Video on my Cisco Unifed Video Camera Appear Too Dark?, page 144](#)
- [Why Does My Phone Not Wake Up?, page 144](#)
- [What Do Four Rings in Succession Mean?, page 145](#)

- [Why Can't I Turn On VXC?, page 145](#)
- [Why Is the VXC VPN Status "Not Connected"?, page 145](#)
- [Why Does VXC Show a "Session Lost" Error?, page 146](#)

Why Can't I See All Active Calls on My Phone?

Question

Why can't I see all the active calls on my phone?

Answer

When there are more calls than available session buttons on the phone, you can scroll to see them. Calls are sorted from oldest to newest, with the oldest call at the top of the list.

How Do I Redirect an Incoming Call?

Question

How do I redirect an incoming call when I am on a call?

Answer

To redirect an incoming (ringing) call while on another call, highlight the incoming call, and then press **Divert**. Otherwise press **Divert** to redirect the current, active call.

How Do I Silence a Ringing Call If I'm On a Call?

Question

How do I silence a ringing call, if I'm on a call?

Answer

You can silence the incoming (ringing) call. Press **Volume** down once, and then let the incoming call go to the target number (voice mail or predetermined number set up the system administrator).

How Do I Resume a Call that is On Hold?

Question

How do I resume a call that is on hold?

Answer

To resume a call on hold, you can use any of the following methods:

- Press the pulsing green session button.
- Press the call session on the phone display (for the Cisco Unified IP Phone 9971 only).
- Press **Resume**.
- Highlight the call by using the Navigation pad and pressing the Select button.
- Press **Hold**.

What Is the Difference Between Buttons on the Left and Those on the Right of the Screen?

Question

What is the difference between the buttons on the left and those on the right of the screen?

Answer

Your phone has feature buttons on the left and call session buttons on the right. Use the feature buttons to access features (such as speed dial) or select a phone line. Use call session buttons to perform call-related tasks, such as making a new call, resuming a held call, or checking your voicemail. The positions of the session buttons and feature buttons can be reversed on phones that use a locale with a right-to-left reading orientation, such as Hebrew and Arabic.

Why Do Softkeys Keep Changing?

Question

Why do the softkeys keep changing?

Answer

Softkeys act on the selected (highlighted) call or menu item only. The softkeys that display depend on the call or item you have selected.

What Is the Best Way to Look at Calls When I Have a Shared Line or Multiple Lines?

Question

What is the best way to look at calls when I have a shared line or multiple lines?

Answer

If you have a shared line or multiple lines, it is recommended that you use the All Calls feature to view calls. When you press the **All Calls** button (on the left), all calls for all your lines are listed on the phone screen in chronological order (oldest first). If you do not have an **All Calls** button, contact your system administrator to set up this feature. Your administrator can also set up your primary line key to act the same as the **All Calls** button.

What Should I Do If I Accidentally Press a Button While on a Call?

Question

What should I do if I accidentally press a button while on a call?

Answer

If you are on a call and press a button for another line, your line view will change. Your current call disappears from view and calls for the newly selected line are displayed. To redisplay the call you are on, select the line that it is on, press **All Calls**, or, press the **Primary line** key if it is set up by your administrator to display all calls.

How Do I Check Missed Calls?

Question

How do I check missed calls on my phone?

Answer

To check missed calls on your phone:

- Press **Applications**, select **Call History**, and press **Missed**.
- Press **Missed Calls**.

How Do I Exit from a Running Application?

Question

How do I exit from a running application?

Answer

To exit from a running applications you must:

- 1 Press **Applications** .

- 2 Use the Navigation pad and Select button to scroll and select **Running Applications**.
- 3 Select a running application and press **Close App** to close the application.
When prompted, save your changes.
- 4 Press **Exit** to end the running application.
If you do not exit a running application, it continues to run in the background.

How Do I Connect Two Calls and then Drop from the Line Myself?

Question

How do I connect two calls and then drop from the line myself?

Answer

When you are on an active call (not on hold), do the following:

- 1 Press **Transfer**  and enter the transfer recipient's phone number in one of these ways:
 - Press the session button of a held call.
 - Enter the transfer recipient's phone number.
 - Scroll to a Call History record and press **Call**.
 - Press a speed-dial button.
 - Press **Speed Dial**, enter a speed-dial number or highlight the number you want to call, and press **Speed Dial** again.
 - Press **Active Calls** and select a held call. The transfer completes immediately.
- 2 Press **Transfer** again. You do not have to wait for the recipient to answer to complete the transfer.

What Does the Swap Softkey Do?

Question

What does the Swap softkey do?

Answer

The **Swap** softkey allows you to toggle between two calls before completing the transfer or creating a conference. This allows you to consult privately with the party or parties on each call before combining the calls into a conference.

How Do I Cancel a Conference or Transfer After I Start It?

Question

Can I cancel a conference or transfer procedure after I have started it?

Answer

Yes, before completing a conference or transfer, you can press **Release**  or **Cancel** to cancel it.

How Can I Combine Two Calls Into a Single Conference Call?

Question

How can I combine two calls on hold into a single conference call?

Answer

Make sure that one of the calls is active (not on hold). If both calls are on hold, resume one call, and then:

- 1 Press **Conference** .
- 2 Press the line button for the other (held) call.

The conference begins. The conference is established on the line that had the active call.

Where Should I Mount My Cisco Unified Video Camera?

Question

Should I mount my Cisco Unified Video Camera on my phone or on my computer monitor?

Answer

For casual video calling, a camera mounted directly on the phone is recommended. If you plan to turn to face your computer monitor often (for example, if you are presenting slides), a camera mounted on monitor might be preferable. Experiment with both and see what works best for you.

If you prefer to mount your camera on your computer monitor, ask your system administrator for a camera mounting clip and USB extension cable.

How Can I Prevent Theft of my Cisco Unified Video Camera?

Question

How can I keep my Cisco Unified Video Camera secure to prevent theft?

Answer

If you are concerned about theft, you can place the camera in a locked drawer when not in use. If you plan to remove the camera regularly for this reason, consider attaching the camera to a USB extension cable (available from your system administrator) rather than mounting the camera directly on the phone.

Connecting and disconnecting the camera is easy and neither resets the phone nor disrupts the audio portion of an active call. However, you may find connecting and disconnecting the camera easier if a USB cable is used rather than directly removing and reattaching the camera to the phone.

Note that the Cisco wall mount kit contains a security mechanism which locks the camera to the phone.

Why can I not see video on a call?

Question

Why can I not see video on a call?

Answer

To see an image of the other party on your phone screen, the other party's phone must support video and the other party must have a camera installed and enabled on the phone. During conference calls, the conference system used during the call must support video conferencing.

What Does the Preview Softkey Do?

Question

What does the Preview softkey do?

Answer

If you have a Cisco Unified Video Camera installed on your phone, you can press **Preview** to see the view from your camera when you are not in a video call. Try using **Preview** before making video calls to help set up and position your camera effectively.

What Happens to Video When I Put a Call On Hold?

Question

What happens to video when I put a call on hold?

Answer

Video transmission is blocked until you resume the call.

What Do the Light Colors on My Cisco Unified Video Camera Indicate?

Question

What do the different light colors on my Cisco Unified Video Camera indicate?

Answer

The colors indicate video transmission states as follows:

- Green: Your video is transmitting.
- Red: Your video is muted.

How Do I Close the Shutter on my Cisco Unified Video Camera?

Question

How can I close the shutter on my Cisco Unified Video Camera?

Answer

Close the camera shutter by rotating the camera lens clockwise. Rotate counter-clockwise to open the shutter again

Why Does the Video on my Cisco Unified Video Camera Appear Too Dark?

Question

Why does video from my Cisco Unified Video Camera appear too dark (or too light)?

Answer

Lighting conditions (such as windows and ceiling lights) within the camera field of view affect the brightness. Try moving the camera to see if the brightness improves. You can also adjust the brightness setting.

Why Does My Phone Not Wake Up?

Question

Why does my phone not work “wake up” when it worked before?

Answer

If your system administrator has set up your phone for EnergyWise, the phone may be sleeping (powered down). Your system administrator sets your phone to sleep at a certain time and wake (power up) at a certain time. Your phone wakes up at the time your system administrator configured. You can press the **Select** button to wake your phone up. Contact your system administrator to have the sleep and wake up times changed.

What Do Four Rings in Succession Mean?

Question

My phone played the ring tone four times in succession, but there is no call. What does this mean?

Answer

The phone is notifying you that your phone will power down (sleep) soon to conserve energy (the EnergyWise feature). Your system administrator sets your phone to sleep at a certain time and wakes (power up) at a certain time. Your phone wakes up at the time your system administrator configured, or you can press Select to wake it up. Contact your system administrator to have the sleep and wake up times changed.

Why Can't I Turn On VXC?

Question

Why can't VXC be turned on?

Answer

Sometimes the VXC device can't get power from the phone. Make sure that the phone is powered by a power brick or a PoE+ switch. If the issue persists, power cycle the phone.

Why Is the VXC VPN Status "Not Connected"?

Question

Why is the VXC VPN status "Not Connected" when the phone VPN status is "Connected" and the VXC device is turned on?

Answer

Sometimes the VXC device can't be detected by the phone. Make sure the VXC device is directly connected to the phone PC port, and then power cycle the VXC device.

Why Does VXC Show a "Session Lost" Error?

Question

Why does VXC show a "session lost" or "signal in another monitor" error?

Answer

This issue happens with VXC2111 in some scenarios. Plug the monitor into display port 0, which is the furthest display port on the right from the phone point of view.



Troubleshooting

- [Missing Alert Calls Button, page 147](#)
- [Missing All Calls Button, page 147](#)
- [Cannot Sign In to the Personal Directory, page 148](#)
- [Cannot Access the Self Care Portal, page 148](#)
- [Security Error Message, page 148](#)
- [Report Call Quality Issues, page 149](#)
- [Documentation, Service Requests, and Additional Information, page 149](#)

Missing Alert Calls Button

Issue

I would like to use the Alert Calls button but it is not on my phone.

Possible Cause

It has not been set up by your system administrator.

Solution

Contact your system administrator to enable the Alert Calls feature for you.

Missing All Calls Button

Issue

I would like to use the All Calls button, but it is not on my phone.

Possible Cause

It has not been set up by your system administrator or your system administrator may have set up your phone so that the primary line button performs the All Calls function.

Solution

Contact your system administrator to enable the All Calls feature for you or check with your administrator about the primary line button functionality.

Cannot Sign In to the Personal Directory

Problem

You can't sign in to your personal directory.

Possible Cause

- You are using your password to sign in, not your personal identification number (PIN).
- Your PIN must be reset.

Solution

- Use your PIN, not your password.
- Contact your administrator.

Cannot Access the Self Care Portal

Problem

You can't access your Self Care Portal.

Possible Cause

Your password must be reset or your administrator may have changed your access to the pages.

Solution

Contact your administrator.

Security Error Message

Problem

Your phone displays `Security Error`.

Cause

Your phone firmware has identified an internal error.

Solution

If the message persists, contact your administrator.

Report Call Quality Issues

Your administrator may temporarily configure your phone with the Quality Reporting Tool (QRT) to troubleshoot performance problems. Depending on the configuration, use the QRT to:

- Immediately report an audio problem on a current call.
- Select a general problem from a list of categories and choose reason codes.

Procedure

-
- Step 1** Scroll and select the item that closely matches your problem.
- Step 2** Press the **Select** softkey to send the information to your system administrator.
-

Documentation, Service Requests, and Additional Information

For information about how to obtain documentation, submit a service request, and gather additional information, see the monthly publication What's New in Cisco Product Documentation. This publication also lists all new and revised Cisco technical documentation at <https://www.cisco.com/c/en/us/td/docs/general/whatsnew/whatsnew.html>.

Subscribe to the What's New in Cisco Product Documentation as a Really Simple Syndication (RSS) feed. Use a reader application to set content for direct delivery to your desktop. The RSS feeds are a free service, and Cisco currently supports RSS Version 2.0.



Product Safety and Security

- [Safety and Performance Information, page 151](#)
- [Compliance Statements, page 153](#)
- [Cisco Product Security Overview, page 154](#)
- [Important Online Information, page 155](#)

Safety and Performance Information

Power Outage

Your access to emergency service through the phone requires that the phone receive power. If a power interruption occurs, service or emergency calling service dialing does not function until power is restored. If a power failure or disruption occurs, you may need to reset or reconfigure the equipment before you can use service or emergency calling service dialing.

External Devices

We recommend that you use good-quality external devices that are shielded against unwanted radio frequency (RF) and audio frequency (AF) signals. External devices include headsets, cables, and connectors.

Depending on the quality of these devices and their proximity to other devices, such as mobile phones or two-way radios, some audio noise may still occur. In these cases, we recommend that you take one or more of these actions:

- Move the external device away from the source of the RF or AF signals.
- Route the external device cables away from the source of the RF or AF signals.
- Use shielded cables for the external device, or use cables with a better shield and connector.
- Shorten the length of the external device cable.
- Apply ferrites or other such devices on the cables for the external device.

Cisco cannot guarantee the performance of external devices, cables, and connectors.

**Caution**

In European Union countries, use only external speakers, microphones, and headsets that are fully compliant with the EMC Directive [89/336/EC].

Bluetooth Wireless Headset Performance

Cisco IP phones support Bluetooth Class 2 technology when the headsets support Bluetooth. Bluetooth enables low-bandwidth wireless connections within a range of 30 feet (10 meters). The best performance is in the 3- to 6-foot (1- to 2-meter) range. You can connect up to five headsets, but only the last one connected is used as the default.

Because of potential interference issues, we recommend that you move 802.11b/g devices, Bluetooth devices, microwave ovens, and large metal objects away from the wireless headset.

The Bluetooth wireless headset does not need to be within direct line-of-sight of the phone. However, some barriers, such as walls or doors, and interference from other electronic devices, can affect the connection.

Ways to Provide Power to Your Phone

You can provide power to your phone in one of two ways:

- Use the power adapter that comes with your phone.
- If your network supports Power over Ethernet (PoE), you can plug your phone into the network. Plug an Ethernet cable into the Ethernet phone port  and into the network.

If you are not sure whether your network supports PoE, check with your administrator.

Phone Behavior During Times of Network Congestion

Anything that degrades network performance can affect phone voice and video quality, and in some cases, can cause a call to drop. Sources of network degradation can include, but are not limited to, the following activities:

- Administrative tasks, such as an internal port scan or security scan
- Attacks that occur on your network, such as a Denial of Service attack

Compliance Statements

Compliance Statements for the European Union

CE Marking

The following CE mark is affixed to the equipment and packaging.



Compliance Statements for Canada

This device complies with Industry Canada license-exempt RSS standard(s). Operation is subject to the following two conditions: (1) this device may not cause interference, and (2) this device must accept any interference, including interference that may cause undesired operation of the device.

Avis de Conformité Canadien

Ce dispositif est conforme aux normes CNR exemptes de licence d'Industrie Canada. Le fonctionnement de ce dispositif est autorisé sous réserve des deux conditions suivantes : (1) il ne doit pas produire de brouillage et (2) l'utilisateur du dispositif doit être prêt à accepter tout brouillage radioélectrique reçu même si ce brouillage est susceptible de compromettre le fonctionnement du dispositif.

Compliance Information for Brazil

Art. 6º - 506

This equipment is a secondary type device, that is, it is not protected against harmful interference, even if the interference is caused by a device of the same type, and it also cannot cause any interference to primary type devices.

For more information, go to this URL: <http://www.anatel.gov.br>

Este equipamento opera em caráter secundário, isto é, não tem direito a proteção contra interferência prejudicial, mesmo de estações do mesmo tipo, e não pode causar interferência a sistemas operando em caráter primário.

Site Anatel: <http://www.anatel.gov.br>

FCC Compliance Statements

The Federal Communications Commission requires compliance statements for the following:

FCC Part 15.19 Statement

This device complies with part 15 of the FCC Rules. Operation is subject to the following two conditions: (1) This device may not cause harmful interference, and (2) this device must accept any interference received, including interference that may cause undesired operation.

FCC Part 15.21 Statement

Changes or modifications not expressly approved by the party responsible for compliance could void the user's authority to operate the equipment.

FCC RF Radiation Exposure Statement

This equipment complies with FCC radiation exposure limits set forth for an uncontrolled environment. End users must follow the specific operating instructions for satisfying RF exposure compliance. This transmitter must be at least 20 cm from the user and must not be collocated or operating in conjunction with any other antenna or transmitter.

FCC Receivers and Class B Digital Statement

This product has been tested and complies with the specifications for a Class B digital device, pursuant to Part 15 of the FCC Rules. These limits are designed to provide reasonable protection against harmful interference in a residential installation. This equipment generates, uses, and can radiate radio frequency energy and, if not installed and used according to the instructions, may cause harmful interference to radio communications. However, there is no guarantee that interference will not occur in a particular installation.

If this equipment does cause harmful interference to radio or television reception, which is found by turning the equipment off and on, the user is encouraged to try to correct the interference by one or more of the following measures:

- Reorient or relocate the receiving antenna
- Increase the separation between the equipment or devices
- Connect the equipment to an outlet other than the receiver's
- Consult a dealer or an experienced radio/TV technician for assistance

Cisco Product Security Overview

This product contains cryptographic features and is subject to U.S. and local country laws that govern import, export, transfer, and use. Delivery of Cisco cryptographic products does not imply third-party authority to import, export, distribute, or use encryption. Importers, exporters, distributors, and users are responsible for compliance with U.S. and local country laws. By using this product, you agree to comply with applicable laws and regulations. If you are unable to comply with U.S. and local laws, return this product immediately.

Further information regarding U.S. export regulations can be found at <https://www.bis.doc.gov/policiesandregulations/ear/index.htm>.

Important Online Information

End User License Agreement

The End User License Agreement (EULA) is located here: <https://www.cisco.com/go/eula>

Regulatory Compliance and Safety Information

Regulatory Compliance and Safety Information (RCSI) is located here:

https://www.cisco.com/c/en/us/td/docs/voice_ip_comm/cuipph/all_models/regulatory_compliance/english/install/guide/iphrcsi3.html



Warranty

- [Cisco One-Year Limited Hardware Warranty Terms, page 157](#)

Cisco One-Year Limited Hardware Warranty Terms

Special terms apply to your hardware warranty and services that you can use during the warranty period. Your formal Warranty Statement, including the warranties and license agreements applicable to Cisco software, is available on Cisco.com at this URL: <https://www.cisco.com/go/hwwarranty>.

